

**B V RAJU COLLEGE**

**VISHNUPUR  
BHIMAVARAM**

**FACULTY RESEARCH PUBLICATIONS**

**ACADAMIC YEAR 2020-21**

## INDEX

<b>S. NO</b>	<b>NAME OF FACULTY</b>	<b>DEPARTMENT</b>	<b>PAPER TITLE</b>	<b>PAGE NO</b>
1	B S SEHSAGIRI RAO	PHYSICS & ELEGTRONICS	Properties and Applications of Nanomaterials in Electronics for Health – A Review	5-15
2	K ESWARA PRASAD	PHYSICS & ELEGTRONICS	Properties and Applications of Nanomaterials in Electronics for Health – A Review	5-15
3	K SATYANARAYANA RAJU	PHYSICS & ELEGTRONICS	Properties and Applications of Nanomaterials in Electronics for Health – A Review	5-15
4	B V SATYA PRAKASH	COMMERCE	DIGITAL MARKETING - A POTNETIAL BUSINESS HIGHWAYAHED	16-24
5	Y RAVINDRA SIVA KUMAR	COMMERCE	DIGITAL MARKETING - A POTNETIAL BUSINESS HIGHWAYAHED	16-24
6	D SATYANARAYANA	COMMERCE	Impact of Covid on Economy and Industry- A Sectoral Analysis	25-36
7	N DURGA SOMESWARA RAO	COMMERCE	Public Private Partnership for Transforming India- A Focus	37-47
8	P SYAMALA DEEPTHI	COMMERCE	Public Private Partnership for Transforming India- A Focus	37-47
9	E A V V RAMBABU	LIFE SCIENCES	SCREENING, ISOLATION AND PRODUCTION OF CELLULOSE FROM SOIL	48-71
10	B RADHA SIRISHA	LIFE SCIENCES	SCREENING, ISOLATION AND PRODUCTION OF CELLULOSE FROM SOIL	48-71
11	V A S S D V PRASAD RAJU	LIFE SCIENCES	SCREENING, ISOLATION AND PRODUCTION OF CELLULOSE FROM SOIL	48-71
12	B DURGA PRASAD	LIFE SCIENCES	SCREENING, ISOLATION AND PRODUCTION OF CELLULOSE FROM SOIL	48-71
13	DASIKA RAVI KUMAR	CHEMISTRY	A REVIEW ON HUMAN AND ENVIRONMENTAL IMPACTS DUE TO LEAD TOXICITY	72-84
14	JLSS PHANI KUMAR	CHEMISTRY	A REVIEW ON HUMAN AND ENVIRONMENTAL IMPACTS DUE TO LEAD TOXICITY	72-84

15	P RAJENDRA BABU	CHEMISTRY	A REVIEW ON REGULATORY PROTEINS AS POTENTIAL SALIVARY BIOMARKERS IN ORAL CANCER DETECTION	85-92
16	R L SATYANARAYANHA	CHEMISTRY	A REVIEW ON REGULATORY PROTEINS AS POTENTIAL SALIVARY BIOMARKERS IN ORAL CANCER DETECTION	85-92
17	S RAMESH	CHEMISTRY	A REVIEW ON REGULATORY PROTEINS AS POTENTIAL SALIVARY BIOMARKERS IN ORAL CANCER DETECTION	85-92
18	R SWAMI SBARIBADH	CHEMISTRY	A REVIEW ON REGULATORY PROTEINS AS POTENTIAL SALIVARY BIOMARKERS IN ORAL CANCER DETECTION	85-92
19	K KRISHNA	ENGLISH	ROBERT GANGNE'S NINE INSTRUCTIONAL MODEL OF SESSION PLAN TO BLOOM'S TAXONOMY LEVELS OF QUESTIONS WITH INNOVATIVE DIGITAL PLATFORMS	93-100
20	CH SATYANARAYANA	MATHEMATICS	A REVIEW ON MATHEMATICAL MODELING OF THE GLUCOSE-INSULIN SYSTEM	101-113
21	P MADHURA SUBHASHINI	MATHEMATICS	A REVIEW ON MATHEMATICAL MODELING OF THE GLUCOSE-INSULIN SYSTEM	101-113
22	D S PRIYADARSINI	MATHEMATICS	A REVIEW ON MATHEMATICAL MODELING OF THE GLUCOSE-INSULIN SYSTEM	101-113
23	M SIVA	MATHEMATICS	A REVIEW ON MATHEMATICAL MODELING OF THE GLUCOSE-INSULIN SYSTEM	101-113
24	DR I R KRISHNAM RAJU	MCA	EVALUTION OF VARIOUS DR TECHNIQUES IN PATIENT DATASETS USING HDFS	114
25	DR K B V BRHMA RAO	MCA	EVALUTION OF VARIOUS DR TECHNIQUES IN PATIENT DATASETS USING HDFS	114
26	DR N PRUDHVI RAJ	MSC	DOMINO PRINS CYCLISATION FOR STEREOSELECTIVE SYNTHESIS OF OXYGEN BRIDGED BICYCLIC	115-121

			<b>THIOETHERS USING AMBERKYST-15</b>	
<b>27</b>	<b>R L SATYANARAYANHA</b>	<b>MSC</b>	<b>DOMINO PRINS CYCLISATION FOR STEREOSELECTIVE SYNTHESIS OF OXYGEN BRIDGED BICYCLIC THIOETHERS USING AMBERKYST-15</b>	<b>115-121</b>
<b>28</b>	<b>J PADMAVATHI</b>	<b>MSC</b>	<b>DOMINO PRINS CYCLISATION FOR STEREOSELECTIVE SYNTHESIS OF OXYGEN BRIDGED BICYCLIC THIOETHERS USING AMBERKYST-15</b>	<b>115-121</b>
<b>29</b>	<b>S RAMESH</b>	<b>MSC</b>	<b>DOMINO PRINS CYCLISATION FOR STEREOSELECTIVE SYNTHESIS OF OXYGEN BRIDGED BICYCLIC THIOETHERS USING AMBERKYST-15</b>	<b>115-121</b>
<b>30</b>	<b>B NAGAMANI</b>	<b>MSC</b>	<b>DOMINO PRINS CYCLISATION FOR STEREOSELECTIVE SYNTHESIS OF OXYGEN BRIDGED BICYCLIC THIOETHERS USING AMBERKYST-15</b>	<b>115-121</b>
<b>31</b>	<b>B KIRAN</b>	<b>PHYSICS &amp; ELECGTRONICS</b>	<b>DESIGN OF AUTOMATED SOLAR LAWN ROWER</b>	<b>122-127</b>





# Properties and Applications of Nanomaterials in Electronics for Health – A Review

B.S.Seshagiri Rao\* K. Eswara Prasad\*\* K.Satyanarayana Raju\*\*\*

Department of Physics & Electronic, B.V. Raju College, Vishnupur, Bhimavaram, West Godavari District, Andhra Pradesh, 534202

**Abstract:** Employments of nanotechnology in gadgets and electrical merchandise that do give rise straightforwardly to natural and human wellbeing concern. This is the utilization of artificially created nanoparticles in 'nanomaterials' to make electronic segments or surface coatings for electrical merchandise. Nanomaterials are usually characterized as materials planned and created to have underlying highlights within any one component of 100 nanometers or less. In hardware, various distinctive nanomaterials are now being utilized economically or are being utilized for innovative work purposes. Probably the most regularly utilized nanomaterials for electronic and electrical hardware are carbon nanotubes and quantum dots nanomaterials are being utilized as surface coatings in certain electrical products, principally in the light of the fact that they have against microbial properties. Items previously showcased as having 'hostile to microbial' nanomaterial coatings incorporate fridges, vacuum cleaners, clothes washers, cell phones and PC mice.

Key words: Nanoparticles (NP). Electronics, Metals.

## Introduction:

Nanotechnology resembles a toolbox for the hardware business. It permits to make nano materials with unique properties changed by super fine molecule size, crystallinity, structure or surfaces. These will turn out to be industrially significant to make new items.

The term 'nano' is utilized in science as a prefix meaning one billionth (utilizing billion in its American feeling of a one followed by nine zeros). A 'nanometer' hence implies one billionth of a meter and it is tiny – around 10 particles across. Nanotechnology alludes to advances that are working at the nanometer level (1) and, all things considered, incorporates both a)

procedures used to fabricate items with nano-scale qualities and b) nanomaterials produced by whatever implies. The two viewpoints have significance in the field of present day gadgets. Nano particles can theoretically be produced artificially from any chemical (2). Such engineered nanomaterials are commonly defined as materials designed and produced to have structural features with at least one dimension of 100 nanometers or less (3). Presently, most nanoparticles that are in use have been made from transition metals, silicon, carbon (carbon nanotubes, fullerenes) and metal oxides (zinc oxide and titanium dioxide). In some cases, engineered nanoparticles exist as nanocrystals composed of a number of compounds such as silicon and metals (as is the case for quantum dots) (4).

Some promising uses of nanomaterials in electronics are

- use of carbon nanotubes in semiconductor chips;
- nanomaterials in lighting advancements (light producing diodes or LEDs and natural light producing diodes or OLEDs), with business utilize expected soon;
- use of 'quantum dots' in lasers, alongside progressing examination into utilization of other nanomaterials in laser innovation;
- utilized in lithium-particle batteries, or which are being investigated for this utilization;
- potential use of carbon nanotubes and other nanomaterials in fuel cells and by the solar industry for use in photovoltaics.
- Research into utilization of nanomaterials to deliver without lead bind, just as the advancement of weld free gathering innovation

## Classification of NPs

NPs are broadly divided into various categories depending on their morphology, size and chemical properties. Based on physical and chemical characteristics, some of the well-known classes of NPs are given as below.

### 1. Carbon-based NPs

Fullerenes and carbon nanotubes (CNTs) speak two significant classes of carbon-based NPs. Fullerenes contain nanomaterial that are made of globular empty pen, for example, allotropic types of carbon. They have made essential business interest because of their electrical conductivity, high strength, structure, electron partiality, and flexibility (5). These materials have masterminded pentagonal and hexagonal carbon units, while every carbon is  $sp^2$  hybridized. Fig. 2 shows a portion of the notable fullerenes comprising of C60 and C70 with the distance across of 7.114 and 7.648 nm, separately.

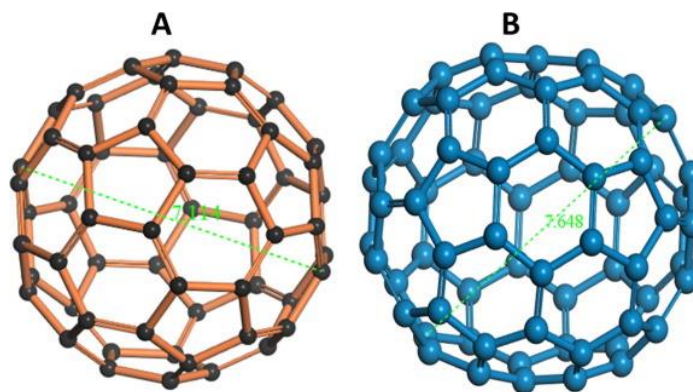

Figure 2. Different forms of Fullerenes/bucky balls (A)  $C_{60}$  and (B)  $C_{70}$ .

CNTs are elongated, tubular structure, 1–2 nm in diameter (6). These can be predicted as metallic or semiconducting reliant on their diameter telicity (7). These are structurally resemble to graphite sheet rolling upon itself (3). The rolled sheets can be single, double or many walled and therefore they named as single-walled (SWNTs), double-walled (DWNTs) or multi-walled carbon nanotubes (MWNTs), respectively. They are widely synthesized by deposition of carbon precursors especially the atomic carbons, vaporized from graphite by laser or by electric arc on to metal particles. Lately, they have been synthesized via chemical vapor deposition (CVD) technique (8). Due to their unique physical, chemical and mechanical characteristics, these materials are not only used in pristine form but also in nanocomposites for many commercial applications such as fillers ( 9,10), efficient gas adsorbents for environmental remediation (11), and as support medium for different inorganic and organic catalysts (12).

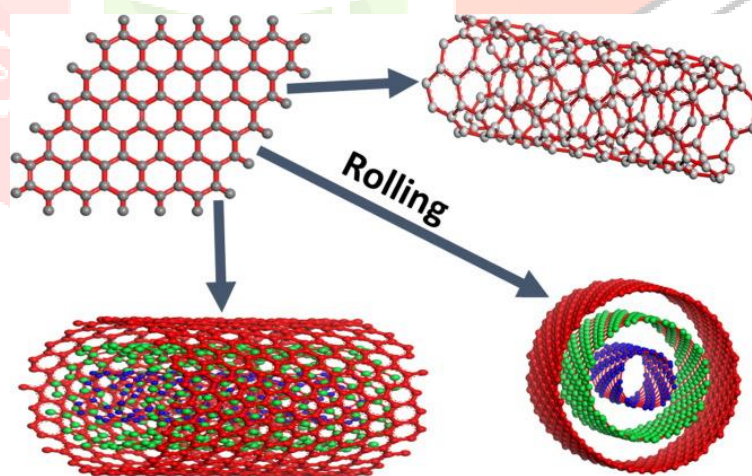

Figure 3. Rolling of graphite layer into single-walled and multi-walled CNTs.

## 2. Metal NPs

Metal NPs are purely made of the metal precursors. Due to well-known localized surface Plasmon resonance (LSPR) characteristics, these NPs possess unique optoelectrical properties. NPs of the alkali and noble metals i.e. Cu, Ag and Au have a broad absorption band in the visible zone of the electromagnetic solar spectrum. The facet, size and shape controlled

synthesis of metal NPs is important in present day cutting-edge materials (13). Due to their advanced optical properties, metal NPs find applications in many research areas. Gold NPs coating is widely used for the sampling of SEM, to enhance the electronic stream, which helps in obtaining high quality SEM images. There are many other applications, which are deeply discussed in applications section of this review.

### **3. Ceramics NPs**

Ceramic NPs are inorganic nonmetallic solids, synthesized via heat and successive cooling. They can be found in amorphous, polycrystalline, dense, porous or hollow forms (14). Therefore, these NPs are getting great attention of researchers due to their use in applications such as catalysis, photocatalysis, photodegradation of dyes, and imaging applications. (15).

### **4. Semiconductor NPs**

Semiconductor materials possess properties between metals and nonmetals and therefore they found various applications in the literature due to this property (16, 17a). Semiconductor NPs possess wide bandgaps and therefore showed significant alteration in their properties with bandgap tuning. Therefore, they are very important materials in photocatalysis, photo optics and electronic devices (Sun, 2000). As an example, variety of semiconductor NPs are found exceptionally efficient in water splitting applications, due to their suitable bandgap and bandsedge positions (18).

### **5. Polymeric NPs**

These are normally organic based NPs and in the literature a special term polymer nanoparticle (PNP) collective used for it. They are mostly nanospheres or nanocapsular shaped (19). The former are matrix particles whose overall mass is generally solid and the other molecules are adsorbed at the outer boundary of the spherical surface. In the latter case the solid mass is encapsulated within the particle completely (20). The PNPs are readily functionalize and thus find bundles of applications in the literature (21,22).

### **6. Lipid-based NPs**

These NPs contain lipid moieties and effectively using in many biomedical applications. Generally, a lipid NP is characteristically spherical with diameter ranging from 10 to 1000 nm. Like polymeric NPs, lipid NPs possess a solid core made of lipid and a matrix contains soluble lipophilic molecules. Surfactants or emulsifiers stabilized the external core of these NPs (23). Lipid nanotechnology (24) is a special field, which focus the designing and synthesis of lipid NPs for various applications such as drug carriers and delivery (25) and RNA release in cancer therapy (26).



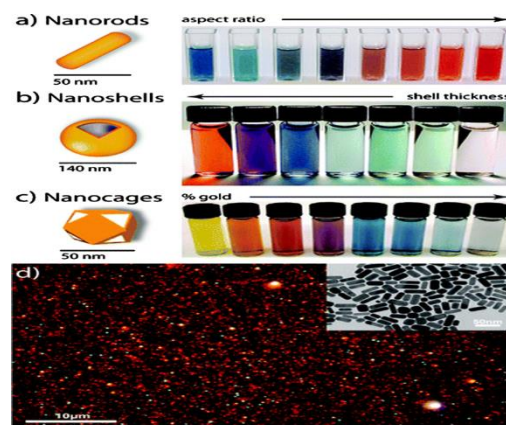

Figure 1

Color dependence of Au NPs on size and shape  
(Dreaden et al., 2012).

Nanoparticles (NPs) have become widely used in electronics, agriculture, textiles, medicine, and many other industries and sciences ([Figure 1](#)). The International Organization for Standardization defines NPs as structures whose sizes in one, two, or three dimensions are within the range from 1 to 100 nm [27,28,29,30,31]. Apart from size, NPs may be classified in terms of their physical parameters, e.g., electrical charge; chemical characteristics, such as the composition of the NP core or shell; shape (tubes, films, rods, etc.); and origin: natural NPs (NPs contained in volcanic dust, viral particles, etc.) and artificial NPs, which are the focus of this review [32]. NP toxicity for living organisms, however, is the main factor limiting their use in treatment and diagnosis of diseases. At present, researchers often face the problem and side effects related to their toxicity. In this respect, the choice of an adequate experimental model for estimating toxicity in vitro (cell lines) and in vivo (experimental animals) ones is of paramount importance. NPs can enter the body through inhalation, skin, and digestion, depending on their physicochemical characteristics and mode of their production [33]. The interactive contact with the body, depending on the type of compounds in NPs, can be respiratory, digestive, or through skin or blood [34]. Some of NPs, such as ZnO and TiO<sub>2</sub>, have the ability to block UV rays and are extensively used in various health products on the market, which raise concerns about the risk to health, safety and the environment as they are dispersed in the environment. According to primary studies, NPs can enter human body in different ways and they can access vital organs in the body through the blood flow and induce damage to tissues and cells [27, 34, and 35]. Although the mechanism of NPs in this regard is not truly established, researchers have associated the toxicity of NPs to parameters such as particle shape, size, dispersity, surface charge and protein corona effects. Several studies have indicated that NPs activate oxidative stress and expression of genes involved in inflammation [36, 37,38]. NPs can enter the human body through respiration, ingestion, and injection and consequently accumulate into different tissues and organs [39, 40,41,42]. NPs can even reach the brain by breaking the strong connection between cells and passing through the blood–brain barrier (BBB); they attach to the cells containing CXCR6 chemokine receptor and overcome tight junction in the BBB [43]. The NPs' passage through the membrane, their performance,

and their cell metabolism are still being studied and discussed. Thus, herein, we attempt to explain a part of the NPs performance that hopefully can answer whether NPs have destructive and toxic effects on organs, or are they safe enough [32]. Development of safe, biocompatible NPs that can be used for the diagnosis and treatment of human diseases can only be based on a complete understanding of the interactions between all of the factors and mechanisms underlying NP toxicity.

## **Medical Applications of Nanoparticles**

In medicine, NPs can be used for diagnostic or therapeutic purposes. In diagnosis, they can serve as fluorescent labels for detection of biomolecules and pathogens and as contrast agents in magnetic resonance and other studies. In addition, NPs can be used for targeted delivery of drugs, including protein and polynucleotide substances; in photodynamic therapy and thermal destruction of tumors, and in prosthetic repair [44]. Some types of NPs have been used extensively in drug delivery, diagnosis of diseases and the provision of biologic sensors; several nanometals have been produced and evaluated, but gold and silver are the most widely used. These particles can be prepared in different sizes and shapes, with small particle size distribution. One of the unique features of these particles is their optical behavior change by changing the particle size, meaning that NPs of different sizes exhibit different colors at visible wavelengths. This feature can be used for diagnosis of the disease and eventual drug delivery to facilitate both these processes. The surface variation of these particles is easy to manipulate as various ligands such as sugars, peptides, proteins, and DNA can bind to these particles [45].

## **Mechanisms of Nanoparticle Toxicity: NP-Cell Interactions**

Surface properties of NPs, to be specific hydrophobicity and hydrophilicity, influence a considerable number of natural ecological reactions of these structures, for example, connection with plasma proteins, cell take-up and phagocytosis, incitement of the safe framework and molecule expulsion. The surface properties of nanoparticles bring about various cell reactions, for example, grip, development and separation. The oxidative pressure is instigated by NPs through physicochemical communication in the cell film as they produce particles which are harmful in the cell layer surface and that can be misused to dispense with malignant cell [46]. The higher the breadth of the NPs, the more their collaboration with the outside layer and the higher the degree of cell harmfulness. The cell layer is perplexing and dynamic containing proteins and extracellular polymeric materials.

## **The Effect of NP on the Protein Conformational Changes**

A number of techniques such as nuclear magnetic resonance (NMR) spectroscopy [47], X-ray crystallography [48], circular dichroism spectroscopy [49], isothermal calorimetry [50], differential scanning calorimetry [51], fluorescence spectroscopy [52], and UV-visible

spectroscopy [53] have been widely used for analyzing the protein-NP interactions. The NP-induced conformational changes and subsequent corona formation depends on several factors such as, protein type, NP type, size of NP, shape of NP,  $P^H$  and the temperature.

The use of materials in nanoscale provides unparalleled freedom to modify fundamental properties such as solubility, diffusivity, blood circulation half life drug release characteristics and immunogenicity. In the last two decades, a number of NP based therapeutic and diagnostic agents have been developed for the treatment of cancer, diabetes, pain, asthma, allergy, infection and so on. These nanoscale agents may provide more effective and/or more convenient routes of administration lower therapeutic toxicity extend the product life cycle and ultimately reduce health care costs. Therapeutic delivery systems and diagnostic applications of NP allow targeted delivery, controlled release and detection on the molecular scale, may help identify abnormalities such as fragments of viruses, precancerous cells and disease makers that cannot be detected with traditional diagnostics. NP based imaging contrast agents have also been shown to improve the sensitivity and specificity of magnetic resonance imaging.

#### **Other Application of Nanotechnology:**

- Chemical sensors, including Hydrogen and glucose sensors;
- Read heads for hard disk drives;
- Transistors, interconnects and integrated circuits (semiconducting and conducting wires); Photo sensors;
- Deposition control systems, a spin off technology for high precision control of particle deposition in the sub-monolayer regime.

#### **Conclusion:**

Nanoparticles have many biomedical applications owing to their unique characteristics such as size, shape, chemistry and charge. However, the signaling pathways through which NPs can produce toxic effects are needed to be understood better. Recent studies have shown that inflammation, necrosis, ROS and apoptosis are key factors that mediate the mechanism of toxicity of NPs. These results may create a barrier to the use of NPs in diagnosis and in the treatment of diseases for which they are ideally suited. It is important to identify the dose, shape, and the properties of NPs that are responsible for their toxicity in order to reduce their side effects by appropriately modifying the formulation or to use a NP with lower toxicity. The dose of NPs is an important factor in their toxicological profile, along with their accumulation, distribution, metabolism and disposal. In line with this, intravenously injected NPs have a higher toxicity than those administered to the skin. According to the results of various studies, protocols explain which doses and what structures of NPs are more toxic. In general, the problems in the evaluation of NP toxicity are due to the disparity between different toxicological studies performed on the NPs of diverse origins and make-up.

Accordingly, the study of NP toxicity in various applications, especially biomedicine applications such as drug delivery, bio-security and NP toxicity, is very crucial. Consequently, there is a need for the development of accepted and specific protocols to identify the actual particle with its surface surroundings and the composition of NPs that renders them toxic. It is hoped that the increased knowledge of NPs lead to develop safer design with reduced toxicity so that they can be used for treatment of assorted diseases and drug delivery.

## References:

1. Whatmore R.W. (2006). Nanotechnology – what is it? Should we be worried? *Occupational Medicine – Oxford* 56 (5): 295-299.
2. Dreher K.L. (2004). Health and environmental impact of nanotechnology: toxicological assessment of manufactured nanoparticles. *Toxicological Sciences* 77: 3-5.
3. Oberdörster G., Maynard A., Donaldson K., Castranova V., Fitzpatrick J., Ausman K., Carter J., Karn B., Kreyling W., Lai D., Olin S., Monteiro-Riviere N., Warheit D. and Yang H. (2005b). Principles for characterizing the potential human health effects from exposure to nanomaterials: elements of a screening strategy. *Particle and Fibre Toxicology* 2:8 (6 October 2005).
4. A. Astefanei, O. Núñez, M.T. Galceran Characterisation and determination of fullerenes: a critical review *Anal. Chim. Acta*, 882 (2015), pp. 1-21, 10.1016/j.aca.2015.03.025.
5. K.S. Ibrahim Carbon nanotubes-properties and applications: a review *Carbon Lett.*, 14 (2013), pp. 131-144,
6. Aqel, K.M.M.A. El-Nour, R.A.A. Ammar, A. Al-Warthan Carbon nanotubes, science and technology part (I) structure, synthesis and characterisation
7. *Arab. J. Chem.*, 5 (2012), pp. 1-23,
8. J.A. Elliott, Y. Shibuta, H. Amara, C. Bichara, E.C. Neyts Atomistic modelling of CVD synthesis of carbon nanotubes and grapheme *Nanoscale*, 5 (2013), p. 6662,
9. K. Saeed, I. Khan Preparation and characterization of single-walled carbon nanotube/nylon 6,6 nanocomposites *Instrum Sci. Technol.*, 44 (2016), pp. 435-444,
10. K. Saeed, I. Khan Preparation and properties of single-walled carbon nanotubes/poly(butylene terephthalate) nanocomposites *Iran. Polym. J.*, 23 (2014), pp. 53-58,
11. J.M. Ngoy, N. Wagner, L. Riboldi, O. Bolland A CO<sub>2</sub> capture technology using multi-walled carbon nanotubes with polyaspartamide surfactant *Energy Procedia*, 63 (2014), pp. 2230-2248,
12. L.F. Mabena, S. Sinha Ray, S.D. Mhlanga, N.J. Coville Nitrogen-doped carbon nanotubes as a metal catalyst support *Appl. Nanosci.*, 1 (2011), pp. 67-77,
13. E.C. Dreaden, A.M. Alkilany, X. Huang, C.J. Murphy, M.A. El-Sayed The golden age: gold nanoparticles for biomedicine *Chem. Soc. Rev.*, 41 (2012), pp. 2740-2779,
14. W. Sigmund, J. Yuh, H. Park, V. Maneeratana, G. Pyrgiotakis, A. Daga, J. Taylor, J.C. Nino Processing and structure relationships in electrospinning of ceramic fiber systems *J. Am. Ceram. Soc.*, 89 (2006), pp. 395-407,
15. S. Thomas, B.S.P. Harshita, P. Mishra, S. Talegaonkar Ceramic nanoparticles: fabrication methods and applications in drug delivery *Curr. Pharm. Des.*, 21 (2015), pp. 6165-6188,



- 16.S. Ali, I. Khan, S.A. Khan, M. Sohail, R. Ahmed, A. Rehman, M.S. Ur Ansari, M.A. Morsy Electrochemical performance of Ni@Pt core-shell nanoparticles supported on carbon nanotubes for methanol oxidation reaction *J. Electroanal. Chem.*, 795 (2017), pp. 17-25,
- 17.Khan, A. Abdalla, A. Qurashi Synthesis of hierarchical WO<sub>3</sub> and Bi<sub>2</sub>O<sub>3</sub>/WO<sub>3</sub> nanocomposite for solar-driven water splitting applications *Int. J. Hydrogen Energy*, 42 (2017), pp. 3431-3439,
- 18.S. Sun Monodisperse FePt nanoparticles and ferromagnetic FePt nanocrystal superlattices *Science*, 80 (287) (2000), pp.
- 19.T. Hisatomi, J. Kubota, K. Domen Recent advances in semiconductors for photocatalytic and photoelectrochemical water splitting *Chem. Soc. Rev.*, 43 (2014), pp. 7520-7535
- 20.M. Mansha, I. Khan, N. Ullah, A. Qurashi Synthesis, characterization and visible-light-driven photoelectrochemical hydrogen evolution reaction of carbazole-containing conjugated polymers *Int. J. Hydrogen Energy* (2017),
- 21.J.P. Rao, K.E. Geckeler Polymer nanoparticles: preparation techniques and size-control parameters *Prog. Polym. Sci.*, 36 (2011), pp. 887-913,
- 22.N.H. Abd Ellah, S.A. Abouelmagd Surface functionalization of polymeric nanoparticles for tumor drug delivery: approaches and challenges *Expert Opin. Drug Deliv.*, 1-14 (2016),
- 23.S.A. Abouelmagd, F. Meng, B.-K. Kim, H. Hyun, Y. Yeo Tannic acid-mediated surface functionalization of polymeric nanoparticles *ACS Biomater. Sci. Eng.* (2016)
- 24.M.K. Rawat, A. Jain, S. Singh, W. Mehnert, A.F. Thunemann, E.B. Souto, A. Mehta, S. P. Vyas Studies on binary lipid matrix based solid lipid nanoparticles of repaglinide: in vitro and in vivo evaluation *J. Pharm. Sci.*, 100 (2011), pp. 2366-2378, 10.1002/jps.22435
- 25.S. Mashaghi, T. Jadidi, G. Koenderink, A. Mashaghi Lipid nanotechnology *Int. J. Mol. Sci.*, 14 (2013), pp. 4242-4282,
- 26.A. Puri, K. Loomis, B. Smith, J.H. Lee, A. Yavlovich, E. Heldman, R. Blumenthal Lipid-based nanoparticles as pharmaceutical drug carriers: from concepts to clinic *Crit. Rev. Ther. Drug Carrier Syst.*, 26 (2009), pp. 523-580
- 27.M. Gujrati, A. Malamas, T. Shin, E. Jin, Y. Sun, Z.-R. Lu Multifunctional cationic lipid-based nanoparticles facilitate endosomal escape and reduction-triggered cytosolic siRNA release *Mol. Pharm.*, 11 (2014), pp. 2734-2744
- 28.Cheng, R.; Feng, F.; Meng, F.; Deng, C.; Feijen, J.; Zhong, Z. Glutathione-responsive nano-vehicles as a promising platform for targeted intracellular drug and gene delivery. *J. Control. Release* 2011, 152, 2-12. [Google Scholar] [CrossRef] [PubMed]
- 29.Sajid, M.; Ilyas, M.; Basheer, C.; Tariq, M.; Daud, M.; Baig, N.; Shehzad, F. Impact of nanoparticles on human and environment: Review of toxicity factors, exposures, control strategies, and future prospects. *Environ. Sci. Pollut. Res.* 2015, 22, 4122-4143. [Google Scholar] [CrossRef] [PubMed]
- 30.Dwivedi, A.D.; Dubey, S.P.; Sillanpää, M.; Kwon, Y.-N.; Lee, C.; Varma, R.S. Fate of engineered nanoparticles: Implications in the environment. *Coord. Chem. Rev.* 2015, 287, 64-78. [Google Scholar] [CrossRef]

31. Ajdari, M.; Ghahnavieh, M.Z. Histopathology effects of nickel nanoparticles on lungs, liver, and spleen tissues in male mice. *Int. Nano Lett.* 2014, 4, 113. [Google Scholar] [CrossRef]
32. Negahdary, M.; Ajdary, M. The toxicity of gold, silver, and zinc oxide nanoparticles on LDH enzyme in male mice. *Annu. Res. Rev. Biol.* 2014, 4, 1346–1352. [Google Scholar] [CrossRef]
33. Hornos Carneiro, M.F.; Barbosa, F., Jr. Gold nanoparticles: A critical review of therapeutic applications and toxicological aspects. *J. Toxic. Environ. Health* 2016, 19, 129–148. [Google Scholar] [CrossRef] [PubMed]
34. Moulton, M.C.; Braydich-Stolle, L.K.; Nadagouda, M.N.; Kunzelman, S.; Hussain, S.M.; Varma, R.S. Synthesis, characterization and biocompatibility of “green” synthesized silver nanoparticles using tea polyphenols. *Nanoscale* 2010, 2, 763–770. [Google Scholar] [CrossRef] [PubMed]
35. Warheit, D.B.; Laurence, B.R.; Reed, K.L.; Roach, D.H.; Reynolds, G.A.; Webb, T.R. Comparative pulmonary toxicity assessment of single-wall carbon nanotubes in rats. *Toxicol. Sci.* 2004, 77, 117–125. [Google Scholar] [CrossRef] [PubMed]
36. Hussain, S.; Hess, K.; Gearhart, J.; Geiss, K.; Schlager, J. In vitro toxicity of nanoparticles in BRL 3A rat liver cells. *Toxicol. In Vitro* 2005, 19, 975–983. [Google Scholar] [CrossRef] [PubMed]
37. Kang, S.J.; Kim, B.M.; Lee, Y.J.; Chung, H.W. Titanium dioxide nanoparticles trigger p53-mediated damage response in peripheral blood lymphocytes. *Environ. Mol. Mutagen.* 2008, 49, 399–405. [Google Scholar] [CrossRef] [PubMed]
38. Xia, T.; Kovoichich, M.; Brant, J.; Hotze, M.; Sempf, J.; Oberley, T.; Sioutas, C.; Yeh, J.I.; Wiesner, M.R.; Nel, A.E. Comparison of the abilities of ambient and manufactured nanoparticles to induce cellular toxicity according to an oxidative stress paradigm. *Nano Lett.* 2006, 6, 1794–1807. [Google Scholar] [CrossRef] [PubMed]
39. Muller, J.; Huaux, F.; Moreau, N.; Misson, P.; Heilier, J.-F.; Delos, M.; Arras, M.; Fonseca, A.; Nagy, J.B.; Lison, D. Respiratory toxicity of multi-wall carbon nanotubes. *Toxic. Appl. Pharmacol.* 2005, 207, 221–231. [Google Scholar] [CrossRef] [PubMed]
40. Mutlu, G.k.M.; Budinger, G.S.; Green, A.A.; Urich, D.; Soberanes, S.; Chiarella, S.E.; Alheid, G.F.; McCrimmon, D.R.; Szleifer, I.; Hersam, M.C. Biocompatible nanoscale dispersion of single-walled carbon nanotubes minimizes in vivo pulmonary toxicity. *Nano Lett.* 2010, 10, 1664–1670. [Google Scholar] [CrossRef] [PubMed]
41. Fard, J.K.; Jafari, S.; Eghbal, M.A. A review of molecular mechanisms involved in toxicity of nanoparticles. *Adv. Pharm. Bull.* 2015, 5, 447–454. [Google Scholar] [CrossRef] [PubMed]
42. Gualtierotti, R.; Guarnaccia, L.; Beretta, M.; Navone, S.E.; Campanella, R.; Riboni, L.; Rampini, P.; Marfia, G. Modulation of neuroinflammation in the central nervous system: Role of chemokines and sphingolipids. *Adv. Ther.* 2017, 34, 396–420. [Google Scholar] [CrossRef] [PubMed]
43. Ma, L.; Zou, X.; Chen, W. A new X-ray activated nanoparticle photosensitizer for cancer treatment. *J. Biomed. Nanotechnol.* 2014, 10, 1501–1508. [Google Scholar] [CrossRef] [PubMed]

44. Guan, X.; Avci-Adali, M.; Alarçin, E.; Cheng, H.; Kashaf, S.S.; Li, Y.; Chawla, A.; Jang, H.L.; Khademhosseini, A. Development of hydrogels for regenerative engineering. *Biotechnol. J.* 2017, 12, 1600394. [Google Scholar] [CrossRef] [PubMed][Green Version]
45. Dorniani, D.; Hussein, M.Z.B.; Kura, A.U.; Fakurazi, S.; Shaari, A.H.; Ahmad, Z. Preparation of Fe<sub>3</sub>O<sub>4</sub> magnetic nanoparticles coated with gallic acid for drug delivery. *Int. J. Nanomed.* 2012, 7, 5745–5756. [Google Scholar] [CrossRef] [PubMed]
46. Benita, S. *Microencapsulation: Methods and Industrial Applications*; Taylor & Francis: Boca Raton, FL, USA, 2006. [Google Scholar]
47. Mishra, A.K. *Nanomedicine for Drug Delivery and Therapeutics*; Wiley: New York, NY, USA, 2013. [Google Scholar]
48. Ceccon, A.; Tugarinov, V.; Bax, A.; Clore, G.M. Global dynamics and exchange kinetics of a protein on the surface of nanoparticles revealed by relaxation-based solution NMR spectroscopy. *J. Am. Chem. Soc.* 2016, 138, 5789–5792. [Google Scholar] [PubMed]
49. Pham, N.; Radajewski, D.; Round, A.; Brennich, M.; Pernot, P.; Biscans, B.; Bonneté, F.; Teychené, S. Coupling high throughput microfluidics and small-angle X-ray scattering to study protein crystallization from solution. *Anal. Chem.* 2017, 89, 2282–2287. [Google Scholar] [CrossRef] [PubMed]
50. Pishkar, L.; Taheri, S.; Makarem, S.; Alizadeh Zeinabad, H.; Rahimi, A.; Saboury, A.A.; Falahati, M. Studies on the interaction between nanodiamond and human hemoglobin by surface tension measurement and spectroscopy methods. *J. Biomol. Struct. Dyn.* 2017, 35, 603–615. [Google Scholar] [CrossRef] [PubMed]
51. Huang, R.; Lau, B.L. Biomolecule–nanoparticle interactions: Elucidation of the thermodynamics by isothermal titration calorimetry. *Biochim. Biophys. Acta Gen. Subj.* 2016, 1860, 945–956. [Google Scholar] [CrossRef] [PubMed]
52. Manyanga, F.; Sithole, A.; Rivera, R.; Karamemedovic, N.; Martin, N. Use of differential scanning calorimetry (DSC) to study the thermodynamics of DNA-based interactions and nucleic acid-based therapeutics. *J. Anal. Pharm. Res.* 2016, 2, 00013. [Google Scholar]
53. Esfandfar, P.; Falahati, M.; Saboury, A. Spectroscopic studies of interaction between cuo nanoparticles and bovine serum albumin. *J. Biomol. Struct. Dyn.* 2016, 34, 1962–1968. [Google Scholar] [CrossRef] [PubMed]



## Digital marketing-a potential business highway ahead

B.V.Stya Prakash, M.Com\*

Y.Raveendra SivaKumar, M.Com\*

\*Lecturers in Commerce, B.V.Raju college, Vishnupur, Bhimavaram-534202

### Abstract

Digital Marketing refers to the marketing of products or services via digital channels to reach consumers. Digital marketing encompasses all marketing efforts that use an electronic device or the internet. Businesses leverage digital channels such as search engines, social media, email, and other websites to connect with current and prospective customers. The role of digital marketing—and of content marketing, specifically—is a huge help to leverage some free advertising and help the business grow. And finally, digital marketing makes it simple to target the exact audience. Focusing on specific target audience increases both customer satisfaction and revenue. With the unfurling of present-day Digital advancements, organizations are doing all that they can to coordinate with the pace to benefit from the advanced role of Digital Marketing for business. Today, many of the business entities have been either changing their channelization into the Digital one or intensifying existing Marketing procedures with Digital methods.

**Key Words:** Content Marketing, Digitalisation, Social commerce,

### INTRODUCTION:

The development of digital marketing is inseparable from technology development. One of the first key events happened in 1971, when Ray Tomlinson sent the first email, and his technology set the platform to allow people to send and receive files through different machines.<sup>[1]</sup> However, the more recognizable period as being the start of Digital Marketing is 1990 as this was where the Archie search engine was created as an index for FTP sites. In the 1980s, the storage capacity of computers was already big enough to store huge volumes of customer information. Companies started choosing online techniques, such as database marketing, rather than limited list broker.<sup>[2]</sup> These kinds of databases allowed companies to track customers' information more effectively, thus transforming the

relationship between buyer and seller. However, the manual process was not as efficient.

Digital India was initiated by the Government of India in 2015. The aim of the initiation is to ensure the government services made available to the citizen electronically. The objective is to make every Indian digitally empowered and all information digitally available. It is intended to make cent percent electronic governance in India. Digital marketing is any form of marketing products and services which involves electronic devices. It can be both online or off line. search engine optimisation, search engine marketing, pay for click advertising, social media marketing, content marketing, mobile marketing, web analytics, marketing automation and content writing and Rate optimisation are the popular and most demanded areas



digital marketing. According to CAM Foundation-Digital Marketing is a broad discipline bringing together all forms of marketing that operates through electronic devices-online, offline, on screen?

### **The Role of Digital Marketing for Business**

Digital Marketing Gives Fair Opportunities to All Kinds of Businesses. Digital Marketing gives fair chance to all kinds of businesses that prefer to go with online branding and advertising. Presently, the role of digital marketing in SME is equally important and effective for small and new business as it is for the well-established businesses. Small and medium scale organizations or new businesses now have the advantages to perform online advertising and lead generations. While thinking about the role of Digital Media Marketing, the most detectable advantage is its capacity to connect with different clients without utilizing call centers. The lead generations and conversions related to Digital Marketing is comparatively way better than different other methods of marketing and advertising.

### **Significance of Digital Marketing**

#### **1. Digital Marketing is Cost Effective**

Independent ventures without any advantages and capitalization locate a predominant and monetarily wise advertising channel in digital advertising. Around 40% of the respondents of Gartner's Digital Marketing Spend Report claim that they are making considerable saving via the digital methods of marketing and advertising.

The report additionally proposes that 28% of organizations examined will move marketing spending allotments from conventional advertising channels and place them into digital promoting channels. Digital advertisers improve Cost-Per-Lead (CPL) compared to other ways of marketing.

#### **2. Digital Marketing Targets Audiences & Convert them into Customers-Source-Social Media**

One motivation behind the role of digital in branding & marketing is that it has a control over other marketing channels is the power of digital strategies to coordinate with exact target audiences and guarantee result driven engagements. Digital Marketing guarantees the commitment that your customers want to get while associating with your business. How you oversee such commitment will decide the success of your marketing strategy. Facilitating your customers with genuine commitment can give you learning of what your prospects require. This will give you a chance to build up the required trust with your audiences when your business begins to develop.

3. Next role of digital marketing in branding is that it plays along with immaculate targeting is conversions. Organizations measure achievement by the rate of traffics getting converted users, subscribers, leads, endorsers, arrangements and deals.

- On the off chance that there happen no conversions, all your action would add up to nothing and all your advertising tries would basically go to waste. There are a couple of CRO





i.e. Conversions Rated Optimization tools that you can use to optimize conversions.

4. Digital marketing is quite significant in ensuring better revenues

Alongside better conversions processed via effective digital advertising methodologies, the role of digital marketing is quite significant in ensuring better revenues. It passes on great beneficial points of interest for you and your business acknowledges better and higher returns on investments. With easy targeting, effective lead generations, powerful conversion, and notable revenue generation, small and medium organizations using digital marketing systems will have 3.3 times better chances of enhancing their business. Digital sectors. Digital Marketing opens the approaches to better, greater and powerful targeting in all the business

### **Digital Marketing Impact on Consumer Behaviour**

Consumers set their own Benchmarks. With the emergence of digital marketing it is not an easy task to woo the consumer senses. For this to happen every brand has to make sure that they maintain their presence on the digital platforms. Word of Mouth- Moment of Truth- TO Moment of Promise. In traditional marketing word of mouth used to be considered as one of the powerful tools of marketing. But in digital era it is the digital word like reviews, testimonials, user and expert ratings that count to influence the customer choice. Now days the consumers are spending most of their time on internet and smart phones for

product information. The Business man accordingly changes their focus of product promotion and make available the marketing content on the digital means.

**Today consumers expect an immediate reaction to their actions.** They want a fast answer to their queries. There are many platforms like Quora, facebook, internet, twitter etc in digital marketing to share their information about brands. According to the human psychology consumers are more attracted towards negative news or reviews and this is generally misused by the competitors. To deal with such a situation every brand, especially the noted brands, have to follow Online Reputation Management strategies (ORM) to make the negative positive. Consumers are always experimenting and standing as Switchers as in the case of Uber, Ola, Oyo, Olx and Nokia to Samsung to Redmi.

### **Role of Digital Marketing in Trust Building**

The significance of Digital Marketing lies in its ability to attract and engage the audiences, who are more than likely to get some answers concerning your image and may be sufficiently fascinated with a Trust to purchase what you convey.

Offering what you ensured will empower you to develop a powerful relationship with them, which eventually influences them to advance into paying customers who will retreat and interface with your site some more in a more loyal manner.

This will be useful for your image building, as the satisfied customers will, no doubt illuminate different people



concerning their inclusion in your brand and enhance your online branding. Your presence will turn into a web sensation; moreover will open new odds of guaranteeing more remote market reach and better business advancement.

“90 percent of respondents asserted they would trust in data about a specific brand, item or service if the information originates from individuals they know.” – Nielsen Global Online Consumer Survey

### **Digital Marketing Helps in Convincing Prospects to Make Moves**

Digital Marketing makes usage of fruitful strategies that will appeal audiences to make a productive move that you expect them to take. It gives you a chance to utilize Calls to Action (CTA) that indicate what your site-guests ought to do straight away. There are creative ways that you can use to guarantee conversions utilizing Calls to Action. They can join, download something, subscribe or make a buy. Digital Marketing gives you a chance to pick and utilize specific advances that will draw prospects make some positive moves. Either B2B or B2C, both kinds of businesses can successfully utilize various Digital Marketing mediums- The main thing that they have to pay regard upon is learning of most recent Digital Marketing patterns that suit their sort of business.

### **Digital Marketing Strategy is the Need of the Hour**

Digital marketing strategy is the series of actions that help you achieve your company goals through carefully selected online marketing channels. These channels include paid, earned, and owned

media. In simple terms, a strategy is just a plan of action to achieve a desired goal, or multiple goals. For example, your overarching goal might be to generate 25% more leads via your website this year than you drove last year. Depending on the scale of your business, your digital marketing strategy might involve multiple digital strategies -- each with different goals -- and a lot of moving parts. But coming back to this simple way of thinking about strategy can help you stay focused on meeting those objectives. Despite our simplification of the term "strategy," there's no doubt it can be difficult to get started actually building one. Let's see what a digital marketing campaign looks like, and then, we'll jump into those seven building blocks to help you create an effective digital marketing strategy to set up your business for online success.

### **DIGITAL MARKETING LANDSCAPE**

The digital marketing landscape is constantly changing. To help you stay ahead of the curve, below we outline the 10 best digital marketing trends 2020.

#### **Shoppable posts (social commerce)**

Social commerce refers to buying products directly through social media posts or ads—you don't need to leave the site or app. These shoppable social media posts aren't exactly new per se, but since Instagram Checkout launched in 2019, they're rapidly getting more and more attention.

#### **Direct Messaging.**

In a bid to get more personal with customers, brands are taking the conversation to DMs. As a means of streamlining customer service and assisting in sales, direct messaging is becoming one of the hottest digital marketing trends of 2020. Through messaging apps like WhatsApp, Viber and



Facebook Messenger, or through private messages on social media like Twitter or Instagram, brands are building stronger connections with their customers. These forums offer the convenience of text with the immediacy of a phone conversation, all in an environment the user is already familiar with from talking with friends.

#### **Micro-influencers-**

Influencer marketing has been a digital marketing trend for a few years now. It's been so successful, though, that big-time influencers are now calling the shots. It's not enough to send them a free sample in hopes they'll review it. Social media "influence" is now a commodity, and an expensive one.

**Polished & interactive emails-** Email marketing now and through 2020 utilizes emails that look and function like web pages—including clickable buttons and other interactions. These highly polished designs do more than just impress, they improve conversions. But nowadays even using webpage-based email templates isn't enough; you have to go the extra mile with stunning visuals and UX-centric designs.

#### **5. Live Video**

Video marketing has been one of the biggest trends in the last two years and it's going to continue in 2020 too. However, this time it's going to be Live Video. Live videos have already been a trend in social media and it is going to expand further into the web. The possibilities of Live Video, in the form of live webinars, shows, live interactive videos, etc. can offer great leverage for brands, marketers and content creators.

#### **6. Big Data & AI**

Big Data and AI have already become part of digital marketing, but still in a developing stage. More developed big data and AI technologies are being incorporated in SEO, content marketing (content strategy, content curation, content recommendation), and campaign planning which are going to play a crucial role in the coming years. With such tools, small businesses too can easily strategize and manage their presence on the web with lesser budget and resources.

#### **7. Precise Targeting and Personalization**

Precise targeting and personalization are the two main ingredients of a successful marketing/advertising campaign. Marketing and advertising campaigns are now being equipped with better data and intelligence so that targeting can be more precise and content/ads can be more personalized. Moreover, marketers and marketing platforms are making sure to accomplish these without compromising their users' privacy.

#### **8. Integration with AR AND VR**

Immersive tech like Augmented Reality (AR) and Virtual Reality (VR) are going to play a significant role in digital marketing in the coming years. Keeping aside VR for now, AR is already being utilized by brands like IKEA which allows its users to test their furniture virtually using its IKEA place app. AR can offer many possibilities for brands and marketers to engage their audience, interact with their prospects and drive them towards purchase. Such possibilities are going to be explored and tested in the following years.





## 9. Chatbots

Conversational/Chatbot marketing has been on the rise in recent times as a more interactive and personal way of marketing. Rather than making the user fill forms on a landing page, chatbots engage the visitors of landing page/website and makes it easier and effortless for them to enter form details or information, make a purchase, subscription etc. in the chat itself. Chatbots have been reported to increase the conversion rates while also providing better and interactive experiences to the users. While most people think of AI/NLP based scripting when someone says chatbots, but that's not the case. There are many pre-scripted chatbots in usage in the market which are performing great. However, chatbots can use AI in a different way in the chat rather than for scripting. Moreover, chatbots are still being improved and developed.

### 10.AI-Based Automation

Will 2020 be the year of the rise of the robots? May be (but hopefully not in the Terminator-style of dystopian science fiction movies!). AI is one of the major technologies behind voice search and smart assistants. Big data, supported by AI and predictive analytics, is also helping brands to learn more about their audience and customers. It's enabling hyper-personalization of customer experiences and marketing messages at scale. Remember, the human aspect of marketing is still important.

## CUSTOMER EXPERIENCE

2020 will be the year of the customer. We're seeing a massive shift in beliefs

about what marketing actually *is*. It's no longer about trying to convince people to buy from or work with your company. Instead, the priority has moved towards providing fantastic customer experiences that will keep people coming back for more. In a sense, when you focus on building a positive business culture and providing great service, the marketing almost takes care of itself. The growth of online content has given consumers more power. They are no longer a passive party when it comes to learning about products. They're not waiting for you to tell you how great your products are. Instead, they are going out and doing their own research.

## STRATEGIC MARKETING TRANSFORMATION

When you're reading about up-and-coming trends in an article like this, it's all too easy to think that being successful in marketing can be simplified to following a list of best practices and making sure you're using the latest techniques and technology. Businesses achieve these benefits through a combination of data collection, using modern technology, building customer relationships and engaging with customers online, publishing quality content, and improving their online presence. All of these things are part of the underlying strategy that influences every department and employee in the company, not just the marketer. Undergoing a marketing transformation can help companies to improve customer service and experience, boost brand awareness and reputation, and ultimately increase revenue and profits.



### Focus on Customer Retention, Loyalty and Advocacy

A huge part of providing a great customer experience is making sure that CX is ongoing and focused on keeping your existing customers, rather than just attracting new ones. Recurring customers are more valuable than new customers. Studies have found that it costs five times as much to attract a new customer as it does to keep a new one, so it's definitely worth putting in the effort to keep your customers happy. The live video industry is expected to be worth over \$70 billion by 2021. Live video is incredibly popular with consumers, and people spend three times longer watching live video than they do watching pre-recorded video. Video is also the most popular way for consumers to learn about new products.

### SOCIAL MEDIA GRIPS BUSINESS AND MARKETING

Social media is one of the most stress-free and profitable digital marketing platforms that can be used to increase your business visibility. ... By spending only a few hours per week, over 91% marketers claimed that their social marketing efforts greatly increased their brand visibility and heightened user experience. Let's start with one simple fact: your business needs a social media presence. It doesn't matter if you run a small local shop or a big national company. Social media is an essential piece of your business marketing strategy. Social platforms help you connect with your customers, increase awareness about your brand, and boost your leads and sales. With more than three billion people around the world using social media every month, it's no

passing trend. What you might not know is that you're ready to get your company's social media off the ground *right now*. You don't need to know every intimidating buzzword or have the magic number of followers. You can get started immediately—and even enjoy yourself in the process.

### Rationale of Investing in Social Media is a wise Business Move.

**Building awareness** If people don't know about your business, they can't become your customers. Social media boosts your visibility among potential customers, letting you reach a wide audience by using a large amount of time and effort. And it's free to create a business profile on all the major social networks, so you have nothing to lose.

### Encourage engagement

Social channels evolve, constantly releasing new features, and this rapidly changing environment can be intimidating for some business owners. But remember you don't have to do everything. Play with new ways to connect with your audience, and give yourself permission to learn as you go. One day, you could post a series of Instagram Stories to give customers a behind-the-scenes tour of your office. The next, you could host a quick Q&A session via Facebook Live video streaming. Over time, you'll get a better idea of your followers' preferences.

### Digital Transformation Trends in future

In the world of digital marketing, too, the future looks bright. There are plenty of reasons to be glad to see the back of 2020, and plenty of reasons to look forward .



The coronavirus pandemic brought online technology to more people, as we all adjusted to working and socialising and teaching our children from home. And, just as there was the sense that people began to rethink their values and remember what's really important to them, so do social values and sustainability feature high on the digital agenda next year. Here are the trends we think will dominate in the years to come.

### **The rise of re-commerce**

According to Thredup's 2020 resale report, the secondhand market will reach \$64bn in value by 2024. Resale, where people sell their pre-loved possessions, will overtake the traditional model of donating and buying goods at thrift stores. The second-hand trend has been given a push by the COVID-19 crisis. Many consumers have had to tighten their belts because their finances have been affected. Others will have found themselves rethinking their buying habits out of a shift in their values. Climate change and the waste and pollution that come from over-consumption are issues that have been growing more urgent since well before the pandemic arrived. Younger generations, especially, care about these issues, and they seek out brands that have found ways to "close the loop" – keep things out of landfill by recycling and re-using, and use the earth's resources in a more responsible, less wasteful way.

### **Brands live their social values**

To succeed sustainably in future, brands will need to think about what their social values are and work out how to express

them in an authentic way. The consumers of today care deeply about the world, the planet and society, whether it's LGBTQ rights, gender equality, anti-racism. If you don't have a clear stance on these issues as a brand, you need to start having one and make sure everyone knows about it. You need to live your values, not just talk about it. Brands regularly get busted if, for example, they profess to care about diversity but their boardrooms look very white and male. Transparency, honesty and authenticity are the secrets to successful purpose marketing. More brands will get on board with this in the coming year.

### **Personalized online education**

If you were to look for silver linings in the year of the pandemic, one would be the great strides that were taken by online learning. With schools shut and lecture halls empty during lockdowns, remote classrooms became the new normal. Online learning became more accessible and accepted in 2020. And in future it will continue to develop and adjust to the requirements of students, young and old. future of e-learning, most notably, is that it will be ever-more personalised. Your location, device, and time-zone will be immaterial as you will be able to create a data-informed, education plan tailored to your own learning style and preferences.

### **Voice will rule the household**

As voice technology becomes more advanced, accepted and trusted, we predict it will begin to replace touch as the search method of choice over the years to come. This trend has been driven, in part, by the coronavirus pandemic.



Younger people, in particular, have become used to smart speakers as their main source of news and entertainment during lockdowns. Moreover, savvy brands have seized the opportunity to provide them with voice apps. Younger people, in particular, have become used to smart speakers as their main source of news and entertainment during lockdowns. Moreover, savvy brands have seized the opportunity to provide them with voice apps. Voice technology will get even more sophisticated over the coming years, and consumers will become more accepting of it. We predict that voice could begin to replace touch as the go-to search method.

#### Brands will up their game

Simple ads are old-school think sophisticated product placement, like 'skinning' where fashion brands 'dress' avatars with luxury clothes. Today, as per the stats, nearly about 60 per cent of the population on the planet uses the Internet. Just two years ago, it was 40%. One can imagine the rate at which people are using the Internet to do almost everything. From ordering foods and vegetables to booking cabs to leasing furniture to people becoming viral influencers, everything has gone digital. A business without a digital presence is bound to go Kaput in no time.

#### References

1. "The Four Faces of Digital Marketing". American Marketing Association. Retrieved 22 August 2019.
2. "Definition of digital marketing". Financial Times. Archived from the original on 29 November 2017. Retrieved 22 August 2015.
3. Nielsen (10 March 2016). "Digital Advertising is Rising in Canada, Requiring More Sophisticated Measures

of Success". Nielsen. Nielsen. Retrieved 25 March 2016.

4. Dahlen, Micael (2010). *Marketing Communications: A Brand Narrative Approach*. Chichester, West Sussex UK: John Wiley & Sons Ltd. p. 36.
5. "Digital Marketing Systems and Techniques". Warwick. Retrieved 28 August 2019.
6. Schoenbachler, Denise D.; Gordon, Geoffrey L.; Foley, Dawn; Spellman, Linda (1997). "Understanding consumer database marketing". *Journal of Consumer Marketing*. 15 (1): 5–19. doi:10.1108/07363769710155820.
7. Clark, Dorie (11 November 2012), "The End of the Expert: Why No One in Marketing Knows What They're Doing", *Forbes*, archived from the original on 4 November 2013
8. Bhat, Suhail Ahmad; Darzi, Mushtaq Ahmad (2016-05-16). "Customer relationship management: An approach to competitive advantage in the banking sector by exploring the mediational role of loyalty". *Intern*
9. Belch, E; Belch, A (2012). *Advertising and promotion: An integrated marketing communication perspective ((9th ed) ed.)*. New York, NY: McGraw-Hill/Irwin.
10. Heikki, Karjaluoto (2015). "The usage of digital marketing channels in SMEs". *Journal of Small Business and Enterprise Development*. 22 (4): 633–651. doi:10.1108/JSBED-05-2013-0073.
11. Pratik Dholakiya (14 April 2015). "3 Digital Marketing Channels That Work for Every Advertiser". *Entrepreneur*. Retrieved 17 October 2015.



## Impact of Covid on Economy and Industry- A Sectoral Analysis

Dasari Satyanarayana, M.Com.,  
Head, Department of Commerce, B.V. Raju College, Vishnupur,  
Bhimavaram-534 202

### ABSTRACT

The wave of Corona Virus in Wuhan-2019 and in Beijing in 2020 and also across different countries of the Globe played havoc and stood as pandemic with human suffering and toll. The Corona Virus Gripped and spread its pangs of Pandemonium over 213 countries of the world. The situation raises more Questions than Answers..Economic Danger Vs. Health Risk. India risked Economic Suicide by extending lockdown much longer up to 5.0 realizing and unlocking from June 8. India's Dream of 5 trillion economy stands as Nightmare. *The Economy is rushed on to the Ventilator and the Industry is pushed into the ICU.* The state Incomes came down drastically- Liquor sales restarted with increased prices-the duties on Petrol – Diesel experienced an unbridled rally standing near Rs.90 per litre. The corona crushed the productive activity, disturbed the economic activity across the sectors of the economy and industry over the entire Globe.

**Key Words:** Atmanirbhar Bharath, Black Swan Event, Vocal for Local

### Introduction

The outbreak of the Novel Corona virus (COVID-19), which originated in Wuhan, China in end-December 2019, has fast spread its tentacles across the world and resulted a major impact on all aspects of society, With the World Health Organization declaring the COVID-19 outbreak a pandemic and an unprecedented global disruption. The corona virus outbreak shut down schools and businesses, imposed social distancing, and completely up ended almost everything we thought of as typical daily life.

People are felt communal anxiety and grief, their daily routines have likely changed completely, and some have either lost their jobs or are risking their health to keep essential services functioning. Given the uncertainty over the duration of the pandemic, the recession is bound to be prolonged still

and the recovery delayed. India, being the fifth largest economy in the world, cannot be seen lagging in taking necessary measures. In CII survey about 45 per cent of the CEOs in India said they don't see economic normalcy returning before a year. Another 36 per cent were more optimistic but it would take 6 to 12 months for economy to function with normalcy. The global COVID-19 pandemic has emerged as the "black swan event which is going to require extraordinary measures from governments across the globe to help resume economic stability.

**SECTORAL IMPACT:** The COVID-19 pandemic impacted the economy across the sectors. These include a) Aviation and Transportation b) Hospitality & Tourism, c) MSME Sector d) Stock Markets, e) Energy & Power, f) E-Commerce, g) Automobile Sector, h) Supply chain & Logistics, i) Real Estate and



construction, i) Migrant Labor, j)Change in the FDI policy, k) Banking Sector

**a)AVIATION AND TRANSPORTATION:**

It is the first affected sector of the economy. Spice jet, Indigo and other state run domestic and international services were disrupted, including the throwing out of the crew. It is with the exception of the emergency and the cargo movers. Aviation is the worst affected sectors under corona virus. Airlines globally lost \$113 billion due to corona. The aviation has been under stress and distress since March,23 and the international flights barred by India up to July,15. Aviation And Tourism Sectors Under Increased Stress Due To Covid-19.Global Aviation activity has sunk by more than 70 per cent in the wake of covid-19.

**b)HOSPITALITY&TOURISM:**

In March 2020, various travel restrictions were imposed by the Governments across the globe. The COVID-19 impact is predicted to derail future growth of Indian tourism and hospitality industries as a result of no countries will permit their citizens. The effect of this Pandemic on the Indian tourism industry will not finish soon in the future because people will not feel safe to travel. The Indian tourism industry is expected to book a revenue loss of Rs 69,400 crore, denoting a year-on-year loss of 30%.72% Employment loss. Hotel Industry experienced a rewinding, because of severe restrictions. United Nations: International tourism could decline by 60-80 per cent in 2020 due to the Covid-19 pandemic, resulting in the revenue loss of \$910 billion to \$1.2 trillion and placing millions of livelihoods at risk, the World Tourism Organization (UNWTO) has said.

**c) MSME SECTOR:**

The Indian MSME sector is the backbone of the national economic structure and has unremittingly acted as the bulwark for the Indian economy, providing it resilience to ward off global economic shocks and adversities. With around 63.4 million units throughout the geographical expanse of the country. Around 51 per cent of these are situated in rural India. MSMEs contribute around 6.11% of the manufacturing GDP and 24.63% of the GDP from service activities as well as 33.4% of India's manufacturing output. They have been able to provide employment to around 120 million persons and contribute around 45% of the overall exports from India. The MSMEs are hit by the onslaught of the pandemic. The demand on the ground has slowed to a trickle. Adding to the woes, a good number of skilled workforces have moved back to their home states due to the prolonged lockdown. The crisis has impacted several MSMEs so hard that many of these entities are unable to even pay salaries to existing workforce and pay rentals, according to industry officials.

According to a survey by the All India Manufacturers' Organisation, about 35 percent of micro, small and medium enterprises and 37 percent of self-employed individuals have started shutting their businesses, saying they saw no chance of a recovery in the wake of the Covid outbreak. The MSME sector in India contributes over 28 percent of GDP and more than 40 percent of exports, while creating employment for about 11 crore people. In other words, MSMEs are one of the major employers in the Indian economy. This is the reason why it is critical for the government to ensure that the MSMEs survive the pandemic.It has also been reported that just like the first relief package, called the





PM Garib Kalyan Yojana, which was announced by the government on March 26, the second package, too, would primarily focus on the MSME sector.

Stimulus packages

Individual countries have announced and initiated implementation of stimulus packages. But the sizes of these packages vary from 9 per cent of GDP in Austria, 5 per cent in France, 4.5 per cent in Germany, only 1.6 per cent in Spain and 1.4 per cent in Italy. Following this Finance minister Mrs. Nirmala Sitharaman announced the tranches. She said that it is not our Dream but it is the responsibility of all of us. The time has come for all of us to analyse the situation before corona and after corona. we should progress by saving our lives. Rs. 20 lakh crores is the Financial stimulus in 2020- the support for Land, Labor, Law and Liquidity

It is to provide liquidity support to MSMEs, village industries and other vulnerable sections

It is stated that Local is our jeevan manthra. Local Market, Local Manufacturing, Local Supply chain, Local Demand to be improved. Local Is Better to grow Global with the slogan-Vocal for Local.

d) STOCK MARKET UNDER DOLDRUMS

With uncertainty persisting in the corporate earnings, investors could face more pain ahead in the coming months. The Indian stock Market has experienced the March Blood bath. Due to the transfusion by the Foreign Portfolio Investors(FPI) and due to the generous stimulus package rolled out by global central banks, the sensx has rallied about 35 per cent since the low recorded on March23. The BSE mid cap and smallcap gained about 37 per cent and 42 per cent respectively. In this regard the

sentiment towards telecom sector improved due to the resilience of the sector during the lockdown. The pharma sector has been the flavor of the season due to higher visibility in earnings growth. The average return of pharma companies in the BSE 500 was almost 60 per cent in the last three months. The stocks of the Aviation companies, Spice jet and Indigo which lingered around the March lows for a long time have seen an uptick by about 50 per cent and 20 per cent respectively, once the flight services resumed. Global stock markets which sunk due to the recession due to the impact of corona virus started floating

e) ENERGY & POWER:

The central government has enforced a nation-wide lockdown between March 25 and June, 8 as part of its measures to contain the spread of COVID-19. During the lockdown, several restrictions have been placed on the movement of individuals and economic activities have come to a halt barring the activities related to essential goods and services. If we look at the consumption pattern by consumer category, in 2018-19, 41% of total electricity consumption was for industrial purposes, followed by 25% for domestic and 18% for agricultural purposes. As the lockdown has severely reduced the industrial and commercial activities in the country, these segments would have seen a considerable decline in demand for electricity. However, note that the domestic demand may have seen an uptick as people are staying indoors. India's growth projections also highlight a slowdown in the economy in 2020 which will further impact the demand for electricity. On April 16, the International Monetary Fund has slashed its projection for India's GDP growth in 2020 from 5.8% to 1.9%.



Note that, as of February 2020, the power sector has the largest share in the deployment of domestic bank credit among industries (Rs 5.4 lakh crore, 19.3% of total).

Due to the demand drop of 46 per cent, Discoms have suffered losses making it difficult for the state governments to meet the challenges. Power producers' total outstanding dues owed by distribution firms rose nearly 63 per cent to Rs 1.23 lakh crore in April 2020 over the same month previous year, reflecting stress in the sector. Distribution companies (discoms) owed a total of Rs 75,642 crore to power generation firms in April 2019,

In the stimulus package of the Government of India provision is made for Meeting Losses of Power sector Units. DISCOMs which provide benefits to the power consumers will be provided Royalties with a stimulus package of Rs.90000 crores.

#### f) SUPPLY CHAIN LOGISTICS-DISRUPTIONS

The coronavirus pandemic is a health crisis like we've never seen before, so it's no surprise that it came with disruptions to the supply chain, hoarding of toilet paper and hand sanitizer, empty shelves at grocery stores, and stress on Amazon's warehouses. 1. Stop, relax, and don't panic. 2. Evaluate your current images, language, and tone of voice. 3. Adjust marketing campaigns and timelines. 4. Have a positive mindset, but don't be insensitive A gold standard for this kind of messaging pivot is what Nike did shortly after Americans were asked to stay home if at all possible.If you ever dreamt of playing for the millions of the world- play inside and play for the world

#### g) E-COMMERCE:

The WTO Work Programme defines "electronic commerce" as the production,

distribution, marketing, sale or delivery of goods and services by electronic means. The World Trade Organization (WTO) has asked its members if there is a need to consider new and practical e-commerce solutions to enable fast and secure cross border movement of goods and services to help economic recovery and job creation after the Covid-19 pandemic. Network capacity and higher bandwidth services have proved to be crucial, not only during the pandemic itself, but also for e-commerce and economic inclusion in general. On line consumer protection and compliance with health and safety regulations are the other challenges, global cooperation in the area of e-commerce, which could help to facilitate cross-border movement of goods and services, narrow the digital divide, and level the playing field for small businesses. The pandemic has made it clear that e-commerce can be an important tool or solution for consumers. E-commerce for goods and services trade has been adversely impacted by the factors that have caused disruption in supply and demand overall and such disruptions have resulted in delivery delays or outright cancellation of orders.

Focusing on ecommerce and D2C in a way that allows for a mix of both retail and online sales is how most brands are finding success during the time of COVID-19. **consumer discretionary spending has dropped over 50%**. With consumers spending less on transportation, travel, restaurants, and childcare in the light of coronavirus, and strong discounts and ad placements being placed near essential items being sold online, non-essential ecommerce has continued to fare well despite this dip.

#### h) AUTOMOBILE SECTOR:

Automobile and component manufacturing plants are being shuttered





around the world, consumer footfalls in showrooms have fallen sharply, vehicle sales are dropping dramatically and almost every major industry event is either being cancelled or going the digital way. All of March has been packed with coronavirus-related news and it all started with the cancellation of the 2020 Geneva Motor Show, which was to open on March 5. Still clouds of uncertainty are hovering over the Indian automotive industry and the coming months are expected to unleash a host of challenges to this sunshine sector. The future road is full of challenges amid a huge tide of unprecedented waves hitting the automotive

In the Indian market, the life of customers revolves around pure economics. Basically the money spent to seal the transaction and sweet deals. Discounts have been the flavour of the Indian automotive market forever. So in the times of the coronavirus pandemic, there's much at stake for the sector. According to industry insiders, the purchase done by potential customers would surely be downsized. So a larger number of customers would be looking at smaller cars with lower price points, leading to downgrade in the purchase and buying decisions. The Rs 10-20 lakh price bracket might be a challenge to sell, while the Rs 20 lakh price upwards would be facing some shrinkage in demand. Indian customers would be looking at affordable mobility with safer means to travel.

Indian passenger vehicle industry declined 18 percent. Most industry pundits are predicting that sales would plummet by another 15-20 percent at least going by the current expected trends. This time is clouded by a worldwide pandemic which has taken a universal toll across continents and is hitting every product and category of the

market. All the global automakers, every visible brand or segment have been hit so much severely. **Startups will go down in dozens.** The steady stream of investments that has kept the Startups going would be the worst to hit. Many of the new Startups in the mobility business would face severe challenges in the months to come. Logger heads with China further accentuate the situation and the Indian dream of bringing the EVS on to the road stands impossible because of the dependence of the Indian Automobile market on China for Auto spares and also the Lithium Batteries. It need be noted that 60 per cent of the Cobalt reserves, the base material for the Lithium batteries, are in China.

#### I) REAL ESTATE AND CONSTRUCTION

The nationwide lockdown due to the COVID-19 pandemic has created an unprecedented predicament. Since millions of workers have migrated to their hometowns due to lack of work, employers are dreading a nightmare scenario. Even when the lockdown is lifted, kick-starting operations will be extremely difficult for almost all sectors. For a labor-intensive industry such as real estate, the reverse migration is tantamount to the last straw on the camel's back. What may make matters worse, paradoxically, are the steps taken by the Centre and States to ensure workers have adequate rations and sustenance wages. Developers are now wondering – why will workers return to cities if they are receiving sustenance at home?

No easy answers exist as COVID-19 is a constantly-evolving crisis. Even if the lockdown is removed, migrant workers could remain reluctant to return because of the uncertainties involved, especially if the coronavirus threat still looms large



over the country. In some instances, migrant workers may still be stuck in cities if they were unable to manage transport back home or were not allowed to move out of their current workplaces. Again, developers may not be able to capitalise on the presence of such 'captive' workers.

Though there is no doubt that the lives of people are important against the unparalleled threat posed by COVID-19, the authorities, including the WHO, are realising that livelihoods are equally critical. Earlier, developers availed of FDI and PE funds to meet liquidity requirements. Unfortunately, due to volatility in the global economy, foreign investors have exited the Indian markets in recent months.

#### K) FDI POLICY CHANGED RESTRICTING THE CHINESE FIRMS UNDUE TAKEOVER OF THE INDIAN ENTITIES.

It was expected that India will really moving into a new Global economic order. In the after math of corona pandemic and thwe resultant asupply disruption the Investors seek to reduce reliance on China as a manufacturing base. India aims to be the next option. India is developing a land pool double the size of Luxemborg(243000 Hects) to lure industry and Business moving out of China. In this regard one meeting was held under the chairmanship of Modi on APRIL 30<sup>th</sup>. A total of 4,61,589 Hects were identified across the country for the purpose. The Govt. has handpicked 10 focus sector for the purpose. A number of state Govts Started amending 38 labor laws in the country to facilitate the foreign players even at the detriment of the labor welfare and workforce in the country. To curb Chinese imports, make Indian manufacturing competitive,

widespread. This scenario certainly defeats the interests of the start-up ecosystem in the country which relies on FDI inflows from China.

#### L) BANKING SECTOR UNDER DISTRESS

The pandemic is impacting the financial services sector in multiple ways — from business continuity issues and operational considerations to the overall financial outlook. The current challenges are likely to translate into high capital infusion requirements for the FIs to maintain both regulatory capital as well as growth capital. "For Asia-Pacific Banks, COVID-19 Crisis Could Add USD 300 Billion To Credit Costs" S&P Global Ratings said, it expects the non-performing assets (NPA) ratio to increase by about 2 per cent in 2020, and credit losses, to increase by about 100 basis points. The NPA ratio in India is likely to fare similarly to China's (1.9 per cent 2 per cent) but the credit costs ratios could be worse, Reporting of losses, increasing rate of NPAs and falling Asset Quality, Increasing credit costs, decline in loan repayment, stress of maratorium on liquidity are the potent problems. Despite the reduction of the repo rate from 75 basis points to 44 basis points, and infusion of capital of Rs.1.37 lakh crores the face of the Banking sector not glowing. The rating agency's credit analyst Gavin Gunning said in the report. Gunning said there are concerns that the coronavirus will spread faster, further, and for longer. If such is the scenario the woes of the banks intensify under coronavirus.

#### Change in FDI policy

Government started disowning the public sector leaving the economy to the private sector. Even the space research and the initiations of space exploration are



opened to the private sector on the same lines of the USA. On 18 April 2020, India changed its foreign direct investment (FDI) policy to curb "opportunistic takeovers/acquisitions" of Indian companies due to the current pandemic", according to the Department for Promotion of Industry and Internal Trade.<sup>[82]</sup> With the fall in global share prices, there is concern that China may take advantage of the situation, leading to hostile takeovers. While the new FDI policy does not restrict markets, the policy ensures that all FDI from countries that share a land border with India will now be under scrutiny of the Ministry of Commerce and Industry.

The Government of India is aiming to attract companies that wish to move out of China or are looking for an alternative to China. The PM's office is conveying to the government central and state machinery to ready pro-investment strategies. A total of at least 461,589 hectares has been earmarked for the purpose, as reported by Economic Times. New FDI rules are intended to keep the Chinese out but the rigid policies will keep the start-ups out. The Government wants to curb their opportunistic takeovers or acquisitions by restricting the FDI rules. But the restrictions may starve the start-ups of needed capital and the technical know-how from the Chinese side. The Indian tech start-ups are in dire need of foreign capital funds. The Indian experts are of the belief that some exceptions to the restrictions will give big relief to the start-up eco-system.

In India up to 53% of businesses have specified a certain amount of impact of shutdowns caused due to COVID-19 on operations (FICCI survey).<sup>1</sup> Various businesses such as hotels and airlines are cutting salaries and laying off employees. By 24 April the Unemployment Rate had

increased nearly 19% within a month, reaching 26% unemployment across India, according to the "Centre for Monitoring Indian Economy". Around 140,000,000 (14 crores) Indian lost employment in the lockdown. More than 45% households across the nation have reported an income drop as compared to the previous year.

On 4 April, former Reserve Bank of India chief Raghuram Rajan said that the coronavirus pandemic in India may just be the "greatest emergency since Independence". The former Chief Economic Advisor to the Government of India has said that India should prepare for a negative growth rate in FY21 and that India would need a Rs.720 lakh crore (US\$10 trillion) stimulus to overcome the contraction.

Numerous companies are carrying out measures within their companies to ensure that staff anxiety is kept at a minimum. Hero MotoCorp has been conducting video townhall meetings, Tata Group has set up a task force to make working from home more effective and the task force at Siemens also reports on the worldwide situation of the COVID-19 pandemic.

#### Agriculture

Due to logistical problems following the lockdown tea estates were unable to harvest the first flush. The impact of this on the second flush is not known. The entire Darjeeling tea based tea industry will see significant fall in revenue. Tea exports could drop up to 8% as a result.

From 20 April, under the new lockdown guidelines to reopen the economy and relax the lockdown, agricultural businesses such as dairy, tea, coffee, and rubber plantations, as well as associated shops and industries, will reopen.

#### IMPACT OF CORONA ON ECONOMY



The economic impact of the 2019–20 corona virus pandemic in India has been largely disruptive. The World Bank and credit rating agencies have downgraded India's growth for fiscal year 2021 with the lowest figures India has seen in three decades since India's economic liberalization in the 1990s. The former Chief Economic Advisor to the Government of India has said that India should prepare for a negative growth rate in FY21 and that the country would need a ₹10 trillion stimulus to overcome the contraction. However, the International Monetary Fund projection for India for the Financial Year 2021-22 of 1.9% GDP growth is the highest among G-20 nations. Within a month, unemployment rose from 6.7% on 15 March to 26% on 19 April. During the lockdown, an estimated 14 crore (140 million) people have lost employment. More than 45% of households across the nation have reported an income drop as compared to the previous year.

Major companies in India such as Larsen and Toubro, Bharat Forge, UltraTech Cement, Grasim Industries, the fashion and retail wing of Aditya Birla Group, Tata Motors and Thermax have temporarily suspended or significantly reduced operations in a number of manufacturing facilities and factories across the country. iPhone producing companies in India have also suspended a majority of operations. Nearly all two-wheeler and four-wheeler companies have put a stop to production till further notice. Many companies have decided to remain closed till at least 31 March such as Cummins which has temporarily shut its offices across Maharashtra. Hindustan Unilever, ITC and Dabur India have shut manufacturing facilities except for

factories producing essentials. Foxconn and Wistron Corp, iPhone producers, have suspended production following the 21 days lockdown orders.<sup>[122]</sup>

E-commerce

In the third week of March 2020, Amazon announced that it would stop sale of non-essential items in India so that it can focus on essential needs. Amazon has followed the same strategy in Italy and France. On 25 March, Walmart-

owned Flipkart temporarily suspended some of its services on its e-commerce platform and will only be selling and distributing essentials. BigBasket and Grofers also run restricted services, facing disruptions in services due to the lockdown. Delhi Police began issuing delivery agents curfew passes to make it easier for them to keep the supply chain open. E-commerce companies also look for legal clarity related to what are "essentials". On 20

April, Telangana extended the lockdown to 7 May. Swiggy and Zomato will not be allowed to function during this extension period.

Defence

The Department of Military Affairs led by the Chief of Defence Staff has postponed all capital acquisitions until the coronavirus pandemic recedes. No new major defense deals will be made in the beginning of the financial year 2020–21. While the delivery of S-400 missile systems won't be affected, the delivery of Rafale fighter jets might be.

An opportunity for reforms

We have entered, to borrow an oft-repeated phrase, 'an era of radical uncertainty' in which we racing to craft appropriate responses, not only to secure safe health outcomes for all, but also to



ensure that lifestyles and livelihoods are protected.

All crises are also opportunities for radical reform, for re-aligning priorities, and for tweaking policies in pursuit of the greater common good. History can serve, in the words of Pulitzer Prize winning writer David McCullough, as “a guide to navigation in perilous times” We might, in these trying times, take inspiration from President Franklin Delano Roosevelt’s ‘New Deal’, a series of reforms enacted between 1933 and 1939 that lifted the United States out of the Great Depression and restored hope to the American people. It focused on the ‘three Rs’ of *relief* for the vulnerable, *recovery* of the economy, and *reform* of the financial system--useful *Mantras* to keep in mind, as India seeks to re-invigorate its economy.

The pandemic has exposed fault lines in the global trade and financial architecture, disrupting our travel patterns, global manufacturing value-chains, and governance systems. The crisis brings home some potent lessons: individual health outcomes cannot be divorced from the health and hygiene systems of the community that national borders are no defense against threats from nature, and that collective global action is increasingly a sine-qua-non for our own individual protection from such events. The hope remains that the COVID-19 crisis brings about a global epiphany regarding the need for saner responses to the other formidable (and less immediately visible) threat: the effects of climate change. Once this episode is behind us, if its only legacy is to bequeath us a wiser and more deliberative approach to balancing the often-conflicting objectives of economic progress and environment protection, then much good would have come of it.

Life after lockdowns: Reviving the economy

Like other countries, India is also seeking to steer a judicious path between the need to insulate the population, and to revive the economic engine. The rigorous national lockdown has succeeded in slowing the spread of the virus, and the current thinking in the government is to open the country for business in a carefully calibrated manner, focusing on reviving sectors like agriculture, manufacturing, and services; while isolating geographic hotspots and vulnerable groups. The most compelling requirement for reviving the economy is to effectively manage the emergence from the lockdown, ensuring that supply chains are reopened, that manufacturing and service enterprises are free to operate, while ensuring basic health hygiene.

The first charge on the government is to protect the lives and entitlements of the most vulnerable people at the bottom of the pyramid-a daunting task, given that the unorganized sector represents over 90 per cent of the workforce<sup>[2]</sup>. India has millions of migrant workers, who are in acute distress, bereft of income support or home comfort. The first round of relief has rightly been the package of INR1.7 trillion for the vulnerable, along with measures like reopening Mahatma Gandhi National Rural Employment Guarantee Act (MGNREGA) work. Much more needs to be done, and much more is expected, particularly a stimulus- cum-relief package that is imminent at the time of writing. There are demands and expectations that this package will be in the region of at least INR5-6 trillion, around 3 per cent of the country’s GDP. This package could encompass fiscal stimulus, liquidity in the system,



tax deferral, credit-protection, and business-continuity and sustenance assistance for small enterprises. The agriculture sector, which constitutes around 15 per cent of the GDP, also needs immediate relief, in terms of facilitating market access for the current *rabi* crop under harvesting, as well as funding support for farmers to commit to the imminent kharif crop, come June.

Apart from agriculture, sectoral stimulus packages and prioritisation of relief and rehabilitation measures are warranted, given the substantial damages inflicted on sectors like tourism, hospitality, transportation, which have very large employment absorption levels.

Another area of focus needs to be infrastructure, not just for creating assets for the future, but also for absorbing employment in sectors like construction. The government's recently announced National Infrastructure Pipeline of around INR100 trillion<sup>[6]</sup> could be re-prioritised by frontloading projects that soak up relatively greater levels of employment.

The prolonged lockdown along with rain and hailstorm in many regions has heightened rural distress, pushing anxious villagers to moneylenders — a situation which farm leaders say can trigger agitations and suicides unless farmers get quick relief. The disruption in wholesale markets and transportation hurdles have ravaged the rural economy. Farmers are chopping orchards, ploughing blooming fields of flowers and selling produce at throwaway prices. The absence of field-level assessment by insurance companies is making compensation difficult. "There is a looming food crisis and I fear hunger deaths may take place if we cannot

address it. According to Du & Bradstreet, COVID-19 no doubt disrupted human lives and global supply chain but the pandemic is a severe demand shock which has offset the green shoots of recovery of the Indian economy that was visible towards the end of 2019 and early 2020. The revised **Gross Domestic Product (GDP)** estimates for India downwards by 0.2 percentage points for the fiscal year 2020 to 4.8 per cent and by 0.5 per cent for the fiscal year 2021 to 6 per cent. Further, it is stated that the extent of the actual impact will depend upon the severity and duration of the outbreak.

There are three major channels of impact for Indian businesses according to the report namely linkages, supply chain and macroeconomic factors. The data of the Dun & Bradstreet shows that at least 6,606 Indian entities have legal linkages with companies in countries with a large number of confirmed COVID-19 cases. And business activity in the foreign markets is slow which implies a negative impact on the top line of these companies. Sectors that would be much affected includes logistics, auto, tourism, metals, drugs, pharmaceuticals, electronic goods, MSMEs and retail among others

#### **Countries coped the pandemic**

The global economy is expected to suffer USD 5.8-8.8 trillion in losses due to the coronavirus pandemic, Asian Development Bank (ADB). It is equivalent to 6.4 per cent to 9.7 per cent of the global GDP. The GDP in south Asia will also be lower by 3.9-6.0 per cent, mainly reflecting the tight restrictions in place in countries like Bangladesh, India and Pakistan, ADB said in its updated assessment of the Potential Economic Impact of COVID-19. The People's





Republic of China (PRC) could suffer losses between USD 1.1 trillion and USD 1.6 trillion.

The International Monetary Fund downgraded its outlook for the coronavirus-ravaged world economy, projecting a significantly deeper recession and slower recovery. The fund said Wednesday it now expects global gross domestic product to shrink 4.9 per cent this year, more than the 3 per cent predicted in April. For 2021, the fund sees growth of 5.4 per cent, down from 5.8 per cent. warned of the biggest slump since the Great Depression, the IMF said its increased pessimism reflected scarring from a larger-than-anticipated supply shock during the earlier lockdown, in addition to the continued hit to demand from social distancing and other safety measures. For nations struggling to control the virus spread, a longer lockdown also will take a toll on growth. The cumulative loss for the world economy this year and next as a result of the recession is expected to reach \$12.5 trillion.

According to an assessment by the World Economic Forum (WEF), supporting SMEs and larger businesses is crucial for maintaining employment and financial stability.

In India, Finance Minister Nirmala Sitharaman has announced some details of the Atmanirbhar Bharat Abhiyan package, to provide relief to Medium, Small and Micro Enterprises (MSMEs) in the form of an increase in credit guarantees.

Many advanced economies in the world have rolled out support packages. While India's economic stimulus package is 10 per cent of its GDP, Japan's is 21.1 per cent, followed by the US (13 per cent), Sweden (12 per cent), Germany (10.7 per cent), France (9.3 per cent), Spain (7.3

per cent) and Italy (5.7 per cent). However, the WEF notes that there is concern that the size of packages may prove insufficient for the duration of the crisis; that disbursement may be slower than is needed; that not all firms in need would be targeted; and that such programs may be overly reliant on debt financing. South Korea stands out, since business and economic activities were not completely stopped and therefore, their economy was not severely affected. China recently lifted its lockdown and has since then been gradually reopening its economy without an aggressive second wave of infections so far.

Further, even as economic activity resumes gradually, the situation will take time to normalise, as consumer behaviours change as a result of continued social distancing and uncertainty about how the pandemic will evolve. For instance, in its *World Economic Outlook* report for 2020, the IMF mentions that firms may start hiring more people and expanding their payroll only slowly, as they may not be clear about the demand for their output.

Therefore, along with clear and effective communication, broad monetary and fiscal stimuli will be required to be coordinated on an international scale for maximum impact, and would be most effective to boost spending in the recovery phase.

A high degree of uncertainty surrounds this forecast with both upside and downside risks. On the upside, better news on vaccines and treatments and further policy support could trigger a faster recovery. On the downside, further waves of infections can reverse increased mobility in spending and rapidly tighten financial conditions, triggering debt distress. Announced fiscal measures



amounting to about \$11 trillion globally, up from \$8 trillion estimated in April, have helped cushion the blow to workers and businesses. But emergency spending by governments is set to push the global debt ratio above 100 per cent for the first time. The IMF presents two alternative scenarios: In one, there's a second virus outbreak in early 2021, with disruptions to domestic economic activity about half the size of those assumed for this year. The scenario assumes emerging markets experience greater damage than advanced economies, given more limited space to support incomes. In the second scenario, with a faster-than-expected recovery, global output would be about a half percentage point better than the baseline this year and 3 per cent above the baseline in 2021.

#### REFERENCES:

1. Vyas, Mahesh (21 April 2020). "Unemployment rate touches 26%". *Centre for Monitoring Indian Economy (CMIE)*. Retrieved 24 April 2020.
2. Sharma, Yogima Seth (24 June 2020). "Unemployment rate falls to pre-lockdown level: CMIE". *The Economic Times*. Retrieved 24 June 2020.
3. Goyal, Malini (22 March 2020). "Covid-19: How the deadly virus hints at a looming financial crisis". *The Economic Times*. Retrieved 23 March 2020.
4. John, Mark (6 May 2020). "How is the world dealing with lockdown? This poll has captured the public's mood". *World Economic Forum*. Retrieved 11 May 2020. 67% of the 13,200-plus people interviewed agreed that: "The government's highest priority should be saving as many lives as possible even if it means the economy will recover more slowly."
5. Khanna, Utpal Bhaskar, Anuja, Pretika (11 April 2020). "Modi says 'jaan bhi jahaan bhi', signals a shift in India's

- coronavirus playbook". *Livemint*. Retrieved 16 April 2020.
6. Padmanabhan, Anil (12 April 2020). "Opinion | New Delhi revisits the lives versus livelihood debate". *Livemint*. Retrieved 16 April 2020.
7. Sharma, Aman (12 May 2020). "Prime Minister Narendra Modi bats for unlocking economy, CMs divided". *The Economic Times*. Retrieved 12 May 2020.
8. Varma, Anuja, Gyan (11 April 2020). "PM Modi's meeting with chief ministers: Five things to watch out for". *Livemint*. Retrieved 16 April 2020.
9. Yadav, Yogendra (15 April 2020). "No matter how you look at it, India's lockdown-2 can cost as many lives as it will save". *ThePrint*. Retrieved 16 April 2020.
10. Slowly increase public activities, PM throws challenge to CMs (Ld). *Outlook India*. IANS. 11 May 2020. Retrieved 12 May 2020.
11. Prime Minister Interacts with the Chief Ministers of all the states and UTs. *pib.gov.in*. 11 May 2020. Retrieved 12 May 2020.
12. Gupta, Shishir (11 May 2020). On exiting Covid-19 lockdown 3.0, PM Modi asks chief ministers to come up with blueprint. *Hindustan Times*. Retrieved 12 May 2020.
13. Misra, Udit (14 May 2020). "PM Modi's Atmanirbhar Bharat Abhiyan economic package: Here is the fine print". *The Indian Express*. Retrieved 17 May 2020.
14. Prasad, Gireesh Chandra (28 April 2020). "India needs a ₹10 rupee stimulus to tide over a contraction in GDP: Subramanian". *Livemint*. Retrieved 29 April 2020.
15. Ray, Anulekha (22 May 2020). "India's GDP growth in 2020-21 to remain in negative territory: RBI". *Livemint*. Retrieved 24 May 2020.





## Public Private Partnership for Transforming India-A Focus

P.Syamala Deepthi, M.Com., and N.Durga Someswara Rao, M.Com., Lecturers in Commerce, B.V.Raju college, Vishnupur, Bhimavaram-534202

### ABSTRACT

PPPs are an important tool for developing infrastructure and therefore fostering economic development. They are used with infrastructures like roads, airports, ports, power, water, and solid waste treatment and typically involve investment and operation and maintenance. PPPs are also used in social infrastructure like health and education, e.g.. construction and maintenance of a hospital or school facilities, but can also include total or partial clinical or education services. According to the National PPP Policy 2011 Government of India is committed to improving the level and the quality of economic and social infrastructure services across the country. In pursuance of this goal, the Government envisages a substantive role for Public Private Partnership (PPPs) as a means for harnessing private sector investment and operational efficiencies in the provision of public assets and services. There's potential for PPPs in any sector. Interesting examples are agriculture or social housing.

**Key Words:** Public Finance Initiative, Lease-Develop-Operate (LDO), Operate-Maintain-Transfer (OMT).

### Introduction

Public-private partnership (PPP) refers to the procurement approach where the project is executed with a broader span of contractual relationships between the public and private sectors to provide an asset and/or a service . It is a procurement model to deliver public infrastructure and/or service crossing various sectors including transportation, water treatment, energy, environment, health, and education . PPP is believed to provide benefits to the public sector, private sector, and consumers by involving the participation of the government and the private financing initiatives . However, conflicting opinions exist considering the negotiation efficiency, service quality, and accountability within PPPs. PPP-based research has aroused wide interests in recent decades. Both developing and

developed countries have actively been inviting private sectors to be involved in constructing infrastructure projects.

The public-private partnership (PPP or 3P) is a commercial legal relationship defined by the Government of India in 2011 as an arrangement between a government / statutory entity / government owned entity on one side and a private sector entity on the other, for the provision of public assets and/or public services.

A public-private partnership is a cooperative arrangement between two or more public and private sectors, typically of a long-term nature. It involves an arrangement between a unit of government and a business that brings better services or improves the city's capacity to operate effectively. A public-private partnership (PPP) is a long-



term contract between a private party and a government entity, for providing a public asset or service, in which the private party bears significant risk and management responsibility, and remuneration is linked to performance. Public-private partnerships involve collaboration between a government agency and private-sector companies that can be used to finance, build, and operate projects, such as public transportation networks, parks, and convention centers. Financing a project through a public-private partnership can allow a project to be completed sooner or make it a possibility in the first place.

#### **Need for PPP**

Economic survey 2009-10 brings out the importance of PPP projects, "PPPs provide variety of benefits in terms of investing public capital to draw in private capital and undertake a bigger number of infrastructure projects, introducing Private sector experience and cost-reducing technologies further leading to efficiencies in operations and maintenance. Hence, other than financial implications, PPPs are unit tools to meet the fundamental obligations of governments to produce higher infrastructure services (with massive externalities), by increasing the answerability of the private sector as a service supplier." The PPP model is needed for ensuring Better Infrastructure, Risk sharing, Optimum allocation of Resources, Value for Money, Innovations, Aid in growth of other Sectors, Catalyst for the Economy, More Employment generation, Improve Image of the country, Increase in GDP and Attracting FDI.

Government of India is committed to improving the level and the quality of economic and social infrastructure services across the country. In pursuance of this goal, the Government envisages a substantive role for Public Private Partnership (PPPs) as a means for harnessing private sector investment and operational efficiencies in the provision of public assets and services.

India has already witnessed considerable growth in PPPs in the last one and half decade. It has emerged as one of the leading PPP markets in the world, due to several policy and institutional initiatives taken by the central as well as many state governments. Government of India has set up Public Private Partnership Appraisal Committee to streamline appraisal and approval of projects.

Transparent and competitive bidding processes have been established. To provide a broader cross sectoral fillip to PPPs, extensive support has been extended through project development funds, viability gap funding, user charge reforms, provision of long tenor financing and refinancing as well as institutional and individual capacity building. PPPs are now seen as the preferred execution mode in many sectors such as highways, ports and airports. Increasingly, PPPs are being adopted in the urban sector and in social sectors. Over the years an elaborate eco-system for PPPs has developed, including institutions, developers, financiers, equity providers, policies and procedures.

#### **Evolution of PPP**

We are in 21st century and still India is an infrastructure deficit country. The need of the hour is to transform India into a developed economy by the integration of vital sectors, networking,



technological advancement and connecting the rural-urban economies. The government sector both at the central and at state level find itself helpless to cope with the growing demands of the economy on its own funds. Hence, need is to look for other sources of development and private participation through PPP which is the best viable option available.

PPP ventures guarantee proficient utilization of assets, accessibility of cutting edge innovation, better venture outline, ideal risk distribution, enhanced deliverance of public services and push to public sector reforms. Under the PPP arrangement, the government part gets re-imagined as one of the facilitators and empowering agents, while the private partner assumes the part of financier, manufacturer and operator of the services. PPPs expect to join the abilities, skill and experience of both people in public and private segments to convey higher gauges of services to clients or residents. The private division brings operational proficiency, creative advanced techniques, administrative efficiencies, access to extra funds, development and business risk sharing. Governments globally have sought to enhance the participation of the private sector in the delivery of public services. These initiatives have taken numerous structures, for example, the out and out privatization of beforehand state-possessed businesses, contracting out of specific services and the utilization of private money in the arrangement of social infrastructure (Private Partnership (PPP) offers a long haul, maintainable way to deal with enhancing public utilities conveyance and social base, upgrading the estimation of public resources and improving utilization of

citizens' funds. This thought of public and private sector going into joint venture is not new and numerous names and short forms (BOT, BOOT, DBOT, PFI, PPP and so forth) have been used for the same policy of providing public services and infrastructure facilities which had formerly been delivered by public sector alone.

There is no exact date and year which could speak of the beginning of PPP but it is said that the PPP story began with private sterling investments in Indian railroads in the latter half of the 1800s. By 1875, about £95 million was put by British organizations in Indian "ensured" railroads. Then again we could follow it to the mid 1900s, when private makers and merchants developed in power sector in Kolkata. A new wave in PPP was felt when a policy was made by the Central government in 1991 and it was decided to allow private participation in the Power sector which opened up the doors for independent power producers. The National Highways Act, 1956 was altered in 1995 to empower private support. In 1994, through a focused offering process, licenses were conceded to eight cell cellular telephone utility.

The major shift in PPP was experienced in true sense when the Infrastructure Development Finance Company (IDFC) was incorporated on 30 January 1997 in Chennai and was laid down upon the recommendations of the "Expert Group on Commercialization of Infrastructure Projects" under the chairmanship of Rakesh Mohan. This was the government's serious initiative towards allowing private participation in infrastructure development by utilizing their expertise, capital and managerial skills.



### How Public-Private Partnerships Work

For example, a city government might be heavily indebted and unable to undertake a capital-intensive building project, but a private enterprise might be interested in funding its construction in exchange for receiving the operating profits once the project is complete.

Public-private partnerships typically have contract periods of 25 to 30 years or longer. Financing comes partly from the private sector but requires payments from the public sector and/or users over the project's lifetime. The private partner participates in designing, completing, implementing, and funding the project, while the public partner focuses on defining and monitoring compliance with the objectives. Risks are distributed between the public and private partners according to the ability of each to assess, control, and cope with them. Public-private partnerships are typically found in transport and municipal or environmental infrastructure and public service accommodations

### Advantages and Disadvantages of Public-Private Partnerships

Partnerships between private companies and government provide advantages to both parties. Private-sector technology and innovation, for example, can help provide better public services through improved operational efficiency. The public sector, for its part, provides incentives for the private sector to deliver projects on time and within budget. In addition, creating economic diversification makes the country more competitive in facilitating its infrastructure base and boosting associated construction, equipment, support services, and other businesses.

There are downsides, too. Physical infrastructure such as roads or railways, involve construction risks. If the product is not delivered on time, exceeds cost estimates, or has technical defects, the private partner typically bears the burden. In addition, the private partner faces availability risk if it cannot provide the service promised. A company may not meet safety or other relevant quality standards, for example, when running a prison, hospital, or school.

Demand risk occurs when there are fewer users than expected for the service or infrastructure, such as toll roads, bridges, or tunnels. If the public partner agreed to pay a minimum fee no matter the demand, that partner bears the risk. Public-private partnerships are typically found in transport infrastructure such as highways, airports, railroads, bridges, and tunnels. Examples of municipal and environmental infrastructure include water and wastewater facilities. Public service accommodations include school buildings, prisons, student dormitories, and entertainment or sports facilities.

### Private Finance Initiative is the lifeline for PPP

A private finance initiative (PFI) is a way of financing public sector projects through the private sector. PFIs alleviate the government and taxpayers of the immediate burden of coming up with the capital for these projects. Under a private finance initiative, the private company handles the up-front costs instead of the government. The project is then leased to the public and the government authority makes annual payments to the private company. These contracts are typically given to construction firms and can last as long as 30 years or more.



PFIs are used primarily in the United Kingdom and in Australia. In the United States, PFIs are also called public-private partnerships. Private finance initiatives were first implemented in the United Kingdom in 1992 and became more popular after 1991.

### **The concern of the World Bank for PPP**

Building modern, sustainable, and reliable infrastructure is critical for meeting the rising aspirations of billions of people around the globe. Infrastructure investment helps raise economic growth rates, offers new economic opportunities, and facilitates investment in human capital. PPPs can be a tool to deliver much needed infrastructure services. When governments choose to use public-private partnerships (PPPs), the World Bank Group helps ensure they're designed well, benefit from a balanced regulatory environment and good governance, and are fiscally sustainable. The World Bank aims to foster better, more efficient public services and infrastructure.

About 800 million people live without electricity, 2.2 billion people lack safely managed drinking water service. Congested and inadequate ports, airports, and roadways are a drag on growth and trade. Public-private partnerships (PPPs) can be a tool to get more quality infrastructure services to more people. When designed well and implemented in a balanced regulatory environment, PPPs can bring greater efficiency and sustainability to the provision of public services such as energy, transport, telecommunications, water, healthcare, and education.

These enormously complex contracts between government and businesses can accomplish what neither side can do alone-expanding infrastructure when funds are limited, for example. But they also contain innumerable pitfalls. The World Bank explains what it takes to create an effective public-private partnership and how they can be used for innovation and capacity building.

### **PPPs for inclusive growth**

The fundamental directive of our constitution specifies that bridging the gap between the rich and poor is the foundation of our nation. The major group of people out of ignorance of these programs are lost in the crowd, thus the benefit does not reach them. It is thus the public private partnership is required to reach the marginalized, the forgotten masses and pull them in to the main stream.

India had the world's third largest fishing industry. India is the largest producer in the world of milk, jute and pulses, and also has the world's second largest cattle population with 175 million animals in 2008. It is the second largest producer of rice, wheat, sugarcane, cotton and groundnuts, as well as the second largest fruit and vegetable producer, accounting for 10.9% and 8.6% of the world fruit and vegetable production respectively. India is also the second largest producer and the largest consumer of silk in the world. Public extension services in the agricultural sector have not kept pace with new challenges and opportunities. An integrated strategy for promotion of agribusiness Vision, Strategy an Action Plan for the Food Processing Sector has also been approved by the Government. Vision 2015 was announced by the



Government of India, which suggested the strategy to ensure faster growth of the food processing sector. 100 per cent foreign direct investment (FDI) is allowed under automatic route in Floriculture, Horticulture, Development of Seeds, Animal Husbandry, Pisciculture, Aquaculture and Cultivation of Vegetables and Mushrooms under controlled conditions and services related to agro and allied sector. A new framework by India's ministry of agriculture to encourage private-public partnerships may open up opportunities for entrepreneurs in the farm sector. Under the new scheme, such PPP projects will be supported by government funds provided to states under the Rashtriya Krishi Vikas Yojana (RKVY).

The public and private partnership sustainable inclusive growth model can become a „in thing“ if it is well designed and well programmed.

India being an agro based economy with the second highest farm output in the world needs more sustainable growth in this area. The public private partnership is one step towards attaining holistic growth. The government alone is not the answer to everything; the need is more than the capital investment. Two third of India's population is depended on agriculture and related activities for their livelihood. This sector is the backbone of the nation and therefore to have a sustainable and inclusive growth. The focus of investment should be moved towards the agriculture and the allied sectors. In the last two decades the agricultural related growth has been slower than in the non agricultural sector contributing to the widening of inequality.

Indian economy is the future of the world and all the nations will be eyeing it very closely. Therefore, to renew the commitment of the nation to achieve the high standards of agriculture production, a call for public private partnership is must. There are many areas in which government alone cannot get success but the leading of government policies and growth at the grassroots level can be achieved through participative work. The call for investments in this area by the foreign direct investment, government machinery and standardization of the mechanism can be done only through the participative mechanism. High standard of technology, training and expertise in agricultural area will help in inclusive growth.

#### **Models and structuring of PPPs**

Commonly adopted models of PPPs include Build-Operate-Transfer (BOT), Build-Own-Operate (BOO), Build-Operate-Lease-Transfer (BOLT), Design-Build-Finance-Operate-Transfer (DBFOT), Lease-Develop-Operate (LDO), Operate-Maintain-Transfer (OMT), etc. The PPPs are the complex long-term contracts. They typically span 15, 20, 25 years, sometimes more, depending on the nature of the project. In that period of time, technology, demographics, environment, and politics can all change, so contracts needs to be flexible to adjust to the project's life cycle. The art of a PPP resides in the allocation of risks of the project and in the definition of the framework, principles, and rules to deal with change, because it will occur. So fundamentally in structuring a PPP contract we need to articulate a set of incentives and penalties to potential actions of the parties, so to ensure the stability and sustainability of the project.





PPPs always take place in the arena of the political economy because the parties contracting are not equal. One party is a government/public entity, and the other one is a private entity. Governments change and so do policies. And in countries where the rule of law is not enough established to maintain the stability of the contract, investors see a significant political risk that will need to be mitigated. This applies to termination of contracts but also to payment risks. A main risk is the regulatory one, e.g., the commitment of government to comply with a tariff law. Adjustment of tariffs can be highly political, particularly in electoral years, and therefore a private project can be easily politicized. Investors seek protection against such risks through guarantees, sometimes backed by a multilateral, international arbitration for dispute resolution and higher returns on equity.

The public party also needs protections from the private partner. Private investors typically provide performance guarantees, sometimes parent guarantees that can be unlimited or capped. If the company doesn't deliver the product or service at the agreed level of quality or the timing contracted if the building isn't finished on time, if the water supply doesn't meet the specified safety levels- the government draws on such guarantees.

As mentioned, to succeed in a PPP, a political champion is critical. It might be a key minister. In certain countries, it requires firm commitment of the president of the country. It has to be someone who can bring the stakeholders along and has the power to make decisions. Another critical key for success

is the speed of a project since they need to be structured and awarded within a political cycle—and those are quite short, since governments change every four or five years.

And something not always well understood is the issue of affordability of users and/or government. Often government projects are overdesigned or built for capacity not materializing in the medium term. The externalization of costs of PPPs often makes these projects unfeasible because they are not financeable without a substantial government subsidy. So when designing PPPs, a particular attention is given to demand analysis and costing, so that a project is economically feasible. We have many cases where we proposed substantial changes to design, such as reducing the footprint of an airport, changing the number of stations in a metro, etc.

Part of why it's important to do things well up front, with all the roles and risks clearly laid out in the contract, is because if there are problems, there's nothing more financially costly and politically embarrassing than interrupting a PPP.

### **PPPs in India and the Government policies**

The Government of India recognizes several types of PPPs, including: User-fee based BOT model, Performance based management/maintenance contracts and Modified design-build (turnkey) contracts. Today, there are hundreds of PPP projects in various stages of implementation throughout the country. As outlined in its XII Five Year Plan (2012–2017), India has an ambitious target of infrastructure investment



(estimated at US\$1 trillion). In the face of such an enormous investment requirement, the Government of India is actively promoting PPPs in many sectors of the economy. According to the World Bank, about 824 PPP projects have reached financial closure since 1990 in India.

The Ministry of Finance centralizes the coordination of PPPs, through its Department of Economic Affairs' (DEA) PPP Cell. In 2011, the DEA published guidelines for the formulation and approval of PPP projects. This was part of an endeavor to streamline PPP procedures and strengthen the regulatory framework at the national level to expedite PPP projects approval, reassure private parties and encourage them to enter into PPPs in India. This was one of the main roles of the Public Private Partnership Appraisal Committee (PPPAC) which is responsible for PPP project appraisal at the central level.

Finally, the PPP Cell has produced a series of guidance papers and a 'PPP Toolkit' to support project preparation and decision-making processes. The objective is to help improve decision-making for infrastructure PPPs in India and to improve the quality of the PPPs that are developed. The toolkit has been designed with a focus on helping decision-making at the Central, State and Municipal levels.

The NDA government has given a fresh lease of life to the public-private partnership (PPP) projects across sectors such as housing, railways, roads, aviation, power distribution, mining and even school education and health services.

PPPs relate to the delivery of public services by private entities, and are awarded through a competitive bidding process. PPP strategy holds promise for infrastructure creation if the financing piece is tied up. The government's renewed focus on PPP will hold infrastructure sector in good stead. For these PPP projects to materialize, the next critical path item will be financing. The PPP model has delivered mixed results in India, given problems on account of overextended balance sheets, contract disputes, land acquisition problems and lack of a dispute resolution mechanism. Stalled projects, in turn, have saddled banks, especially public sector lenders, with large bad loans.

Some of the key PPP projects are in the physical infrastructure space. The Union government in August announced a new metro policy wherein it will approve and aid metro rail projects only if they have private participation and ensure last-mile connectivity for users. Also, a new PPP was announced last month to promote private investments in affordable housing to help achieve the "housing for all" target by 2022.

#### **Benefits associated with PPPs**

1. PPP in infrastructure projects brings efficiency in service delivery, expertise, enterprise and professionalism apart from harnessing the needed investments in the public sector.
2. The PPP in airport infrastructure projects has brought World class infrastructure at airports, delivery of efficient and timely services to the airport passengers, augmenting revenue stream to the Airports Authority of India without making any investment, etc. of these, for development of Greenfield Airports at Hyderabad and Bengaluru. Presently, the airports being managed



under the PPP model include Delhi, Mumbai, Bangalore, Hyderabad and Cochin.

3. The PPP airports in India have been ranked among the top 5 in their respective categories by the Airports Council International (ACI) in terms of Airport Service Quality (ASQ).

4. While these PPP experiments have helped create world class airports, it has also helped AAI in enhancing its revenues and focusing on developing airports and Air Navigation infrastructure in the rest of the country.

India's Pride and major infrastructure projects include the Metro Rail, Chenab Bridge, Qazigund Tunnel and Eastern Freeway along with the Golden Quadrilatera highway network, port connectivity and national waterways. These amazing infrastructure project of India ranked well in the world and makes us proud, other great infrastructure also includes Tehri Dam, Pamban Bridge, Gurgaon Toll Plaza, high rise buildings and big IT parks.

### **Risks Associated with PPPs**

There have been a number of critics associated with Public Private Partnerships in India, in particular related to the risks that come with such partnerships.

It has been argued that PPP involve greater costs than traditional government procurement processes (because of the development, bidding and ongoing costs in PPP projects). Some have questioned the value-for-money relevance of PPP projects in India.

The private sector does not provide a service that is not specifically outlined in the PPP contract. It is thus critical that key performance indicators are precisely

laid out in the contract and that the government monitors closely the work of its private partner.

Furthermore, there is a cost attached to debt and while private sector can help access to finance, if the customers or the government may end up bearing much of this cost.

Another critic of PPP projects is related to their social and political consequences, which can be significant. For example, a PPP project may result in the transfer of civil servants to the private sector, important tariff increases or resettlement issues to name a few.

Finally, PPPs often end up being renegotiated. This is due to the long-term nature of the PPP projects (some run for up to 30 years) and their complexity. It is difficult to identify all possible contingencies during project development and events and issues may arise that were not anticipated in the documents or by the parties at the time of the contract.

Other major drawbacks encountered in 3P projects in India include poorly drafted contracts and lack of understanding of contracts, inadequate resources, lack of managerial experience, breaches of contract, failures in team building, lack of performance measures, corruption and political interference.

### **Conclusion**

The PPP arrangement has been accepted as a substitute to the overall burden of the Indian Government for the expansion of world-class infrastructure development. The time is right to discuss the sudden arrival and pertinence of PPPs in India's development strategy and investigate real alternatives for economic change. PPPs in India had its



own share of obstacles and difficulties but it has been realized that the need of PPP is immense. The future of PPP in India looks bright as the country aims for a higher growth trajectory through strong infrastructure investments. There is significant untapped potential for use of ppp in various new sectors. The Government has to constantly addressing factors constraining private investment and implement appropriate measures to streamline PPP projects. With policymakers keen to involve global firms as well, the next decade promises a swathe of opportunities for domestic and foreign investors alike in the sector. In line with this, the government has undertaken measures to further rationalize PPP processes by formulating a national PPP policy and developing corporate bond markets. The formation of an exclusive PPP department in the DEA to supervise and co-ordinate various PPP proposals was also a part of this initiative. Furthermore, India Infrastructure Finance Company Limited (a non-banking financial company) was established to provide financial support for projects with long gestation period. In addition, to further simplify the compliance process, a Public Private Partnership Committee (PPPAC) was formed. Since 2006 till date, PPPAC has granted approval to projects Likewise, various funds such as Viability Gap Funding Scheme and Project Development Fund have been introduced by the central and the state governments. Some of the state governments – for instance, in Karnataka and Andhra Pradesh – have successfully built an institutional framework to propel PPP investment.

## References

1. A. P. C. Chan, R. Osei-Kyei, Y. Hu, and Y. Le, "A fuzzy model for assessing the risk exposure of procuring infrastructure mega-projects through public-private partnership: the case of Hong Kong-Zhuhai-Macao bridge," *Frontiers of Engineering Management*, vol. 5, no. 1, pp. 64–77, 2018. View at: [Publisher Site](#) | [Google Scholar](#)
2. A. P. Gurgun and A. Touran, "Public-private partnership experience in the international arena: case of Turkey," *Journal of Management in Engineering*, vol. 30, no. 6, Article ID 04014029, 2014. View at: [Publisher Site](#) | [Google Scholar](#)
3. B. Li, A. Akintoye, P. J. Edwards, and C. Hardcastle, "Critical success factors for PPP/PFI projects in the UK construction industry," *Construction Management and Economics*, vol. 23, no. 5, pp. 459–471, 2005. View at: [Publisher Site](#) | [Google Scholar](#)
4. H. P. Tserng, J. S. Russell, C.-W. Hsu, and C. Lin, "Analyzing the role of national PPP units in promoting PPPs: using new institutional economics and a case study," *Journal of Construction Engineering and Management*, vol. 138, no. 2, pp. 242–249, 2012. View at: [Publisher Site](#) | [Google Scholar](#)
5. L. Tang, Q. Shen, M. Skitmore, and E. W. L. Cheng, "Ranked critical factors in PPP briefings," *Journal of Management in Engineering*, vol. 29, no. 2, pp. 164–171, 2013. View at: [Publisher Site](#) | [Google Scholar](#)
6. R. Widdus, "Public-private partnerships for health: their main targets, their diversity, and their future directions," *Bulletin of the World Health Organization*, vol. 79, no. 8, pp. 713–720, 2001. View at: [Google Scholar](#)
7. N. F. D. Cruz and R. C. Marques, "Delivering local infrastructure through PPPs: evidence from the school sector,"



*Journal of Construction Engineering and Management*, vol. 138, no. 12, pp. 1433–1443, 2012. View at: [Publisher Site](#) | [Google Scholar](#)

8. J. Yuan, M. Guang, X. Wang, Q. Li, and M. J. Skibniewski, "Quantitative SWOT analysis of public housing delivery by public-private partnerships in China based on the perspective of the public sector," *Journal of Management in Engineering*, vol. 28, no. 4, pp. 407–420, 2012. View at: [Publisher Site](#) | [Google Scholar](#)

9. J. Song, D. Song, X. Zhang, and Y. Sun, "Risk identification for PPP waste-to-energy incineration projects in China," *Energy Policy*, vol. 61, pp. 953–962, 2013. View at: [Publisher Site](#) | [Google Scholar](#)

10. J. Song, H. Zhang, and W. Dong, "A review of emerging trends in global PPP research: analysis and visualization," *Scientometrics*, vol. 107, no. 3, pp. 1111–1147, 2016. View at: [Publisher Site](#) | [Google Scholar](#)

11. L. Tang, Q. Shen, and E. W. L. Cheng, "A review of studies on public-private partnership projects in the construction industry," *International Journal of Project Management*, vol. 28, no. 7, pp. 683–694, 2010. View at: [Publisher Site](#) | [Google Scholar](#)

12. J. Liu, P. Love, B. Carey, J. Smith, and M. Regan, "Ex-ante evaluation of public-private partnerships: macroeconomic analysis," *Journal of Infrastructure Systems*, vol. 21, no. 2, Article ID 04014038, 2015. View at: [Publisher Site](#) | [Google Scholar](#)

13. L. Tang and G. Q. Shen, "Finance-related critical success factors for the briefing of PPP projects in construction,"

in *Proceedings of the International Conference on Construction and Real Estate Management*, pp. 427–437, Karlsruhe, Germany, October 2013. View at: [Google Scholar](#)

14. M. Soomro and X. Q. Zhang, "Evaluation of the functions of public sector partners in transportation public-private partnerships failures," *Journal of Management in Engineering*, vol. 32, no. 1, Article ID 04015027, 2015. View at: [Google Scholar](#)

15. X. Zhang, "Criteria for selecting the private-sector partner in public-private partnerships," *Journal of Construction Engineering and Management*, vol. 131, no. 6, pp. 631–644, 2005. View at: [Publisher Site](#) | [Google Scholar](#)

16. A. P. C. Chan, J. F. Y. Yeung, C. C. P. Yu, S. Q. Wang, and Y. Ke, "Empirical study of risk assessment and allocation of public-private partnership projects in China," *Journal of Management in Engineering*, vol. 27, no. 3, pp. 136–148, 2011. View at: [Publisher Site](#) | [Google Scholar](#)

17. F. Al-Sharif and A. Kaka, "PFI/PPP topic coverage in construction journals," in *Proceedings of the 20th Annual ARCOM Conference*, pp. 711–719, Edinburgh, UK, September 2004. View at: [Google Scholar](#)

18. Y. Ke, S. Wang, A. P. Chan, and E. Cheung, "Research trend of public-private partnership in construction journals," *Journal of Construction Engineering and Management*, vol. 135, no. 10, pp. 1076–1086, 2009. View at: [Publisher Site](#) | [Google Scholar](#)

# Screening, Isolation and Production of cellulose from Soil.

E.A.V.V Rambabu<sup>1</sup>.M, Radha Sirisha.B, V.A.S.S.D.V Prasad Raju.V and Durga Prasad.B.

DEPARTMENT OF LIFESCIENCES,B.V RAJU COLLEGE,

BHIMAVARAM,WEST GODAVARI DIST,ANDHRA PRADESH,INDIA,PIN:534202.

**\*Corresponding Author:E.A.V.V Rambabu.**

**ABSTRACT:** -Cellulose is the most abundant biological compound on terrestrial and aquatic ecosystem. Cellulose is also the most common organic compound on earth. It is well known that plants are the most common source of renewable carbon and energy on the earth. (Yakubuet *al.*, 2011).Cellulolytic enzymes play an important role in natural biodegradation processes in which plant lignocellulosic materials are efficiently degraded by cellulolytic fungi, bacteria, actinomycetes and protozoa.Cellulose is commonly degraded by cellulase. Cellulolytic enzyme system consists of three major components such as endoglucanases, exoglucanases and  $\beta$ -glycosidase.

**KEY WORDS:**-Cellulose, Terrestrial, Enzymes, Endo-glucanases, Exo-glucanases and  $\beta$ -glycosidase.

## 1. INTRODUCTION

### 1.1 Introduction to cellulose

Cellulose is the most abundant biological compound on terrestrial and aquatic ecosystem and is the main component of plant biomass (Shankar *et al.*, 2011). It is the dominant waste material from agricultural industry in the form of stalks, stems and husk, there has been great interest in utilizing cellulose as an energy resource and feed (Balachandrababuet *al.*, 2012). The cellulose is composed of D-glucose units linked together to form linear chain via  $\beta$ -1, 4-glycosidic linkages (Salmon and Hudson, 1997).

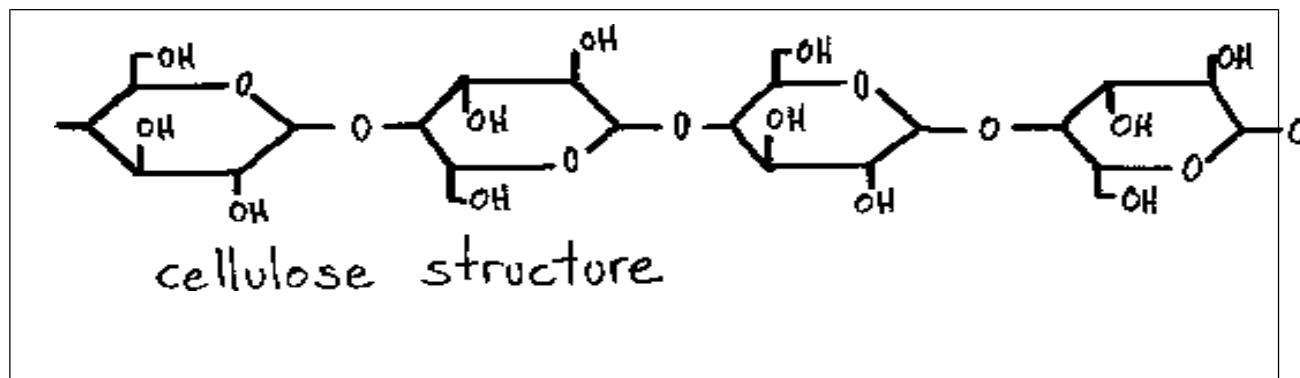

**FIGURE 1.1: STRUCTURE OF CELLULOSE**



Cellulose is also the most common organic compound on earth. It is well known that plants are the most common source of renewable carbon and energy on the earth. (Yakubuet *al.*, 2011). Cellulose is basically the structural component of the primary cell wall of green plants, many forms of algae and the oomycetes. Cellulose is the major component of plant biomass. Plants produce  $4 \times 10^9$  tons of cellulose annually. It is also considered as one of the most important sources of carbon on this planet and its annual biosynthesis by both land plants and marine occurs at a rate of  $0.85 \times 10^{11}$  tons per annum (Nowak *et al.*, 2005).

There are two types of hydrogen bonds in cellulose molecules: those that form between the C<sub>3</sub>OH group and the oxygen in the pyranose ring within the same molecule and those that form between the C<sub>6</sub> OH group of one molecule and the oxygen of the glucosidic bond of another molecule. Ordinarily, the beta-1, 4 glycosidic bonds themselves are not too difficult to break. However, because of these hydrogen bonds, cellulose can form very tightly packed crystallites. These crystals are sometimes so tight that neither water nor enzyme can penetrate them; only *exogluconase*, a subgroup of cellulase that attacks the terminal glucosidic bond, is effective in degrading it. The inability of water to penetrate cellulose also explains why crystalline cellulose is insoluble. On the other hand, amorphous cellulose allows the penetration of *endogluconase*, another subgroup of cellulase that catalyzes the hydrolysis of internal bonds. The natural consequence of this difference in the crystalline structure is that the hydrolysis rate is much faster for amorphous cellulose than crystalline cellulose. The process of breaking the glucosidic bonds that hold the glucose basic units together to form a large cellulose molecule is called *hydrolysis* because a water molecule must be supplied to render each broken bond inactive. In addition to crystallinity, the chemical compounds surrounding the cellulose in plants, e.g. lignin, also limit the diffusion of the enzyme into the reaction sites and play an important role in determining the rate of hydrolysis.

Cellulose degradation and its subsequent utilizations are important for global carbon sources. The value of cellulose as a renewable source of energy has made cellulose hydrolysis the subject of intense research and industrial interest (Bhat *et al.*, 2000). There has been much research aimed at obtaining new microorganisms producing cellulase enzymes with higher specific activities and greater efficiency (Subramaniyan *et al.*, 2000).

## 1.2 Cellulose degrading enzyme

Cellulolytic enzymes play an important role in natural biodegradation processes in which plant

lignocellulosic materials are efficiently degraded by cellulolytic fungi, bacteria, actinomycetes and protozoa. In industry, these enzymes have found novel applications in the production of fermentable sugars and ethanol, organic acids, detergents and other chemicals. Cellulases provide a key opportunity for achieving tremendous benefits of biomass utilization (Wenet *et al.*, 2005). The conversion of cellulose into glucose is now known to consist of two steps in the enzyme system of *Trichoderma viride*. In the first step, beta-1,4glucanase breaks the glucosidic linkage to cellobiose, which is a glucose dimer with a beta-1, 4 bond as opposed to maltose, a counterpart with an alpha-1, 4 bond. Subsequently, this beta-1,4glucosidic linkage is broken by beta-glycosidase:

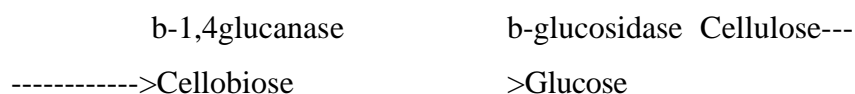

The kinetics of cellulose hydrolysis has been widely studied, and Michaelis-Menten types of rate expressions with substrate or product inhibition terms have been proposed to describe the observed reaction kinetics.

### 1.3 Cellulose degrading microorganisms

Cellulolytic enzymes are synthesized by a number of microorganisms. Fungi and bacteria are the main natural agents of cellulose degradation (Lederberg, 1992). The cellulose utilizing population includes aerobic and anaerobic mesophilic bacteria, filamentous fungi, thermophilic and alkaliphilic bacteria, actinomycetes and certain protozoa (Alexander, 1961). However, fungi are well known agents of decomposition of organic matter, in general, and of cellulosic substrate in particular (Lynd *et al.*, 2002).

Microorganisms bring about most of the cellulose degradation occurring in nature. They meet this challenge with the aid of a multi-enzyme system (Aubert *et al.*, 1987). Aerobic bacteria produced numerous individuals and extra-cellular enzymes with binding modules for different cellulose conformations, while anaerobic bacteria possess a unique extracellular multi enzyme complex, called cellulase. However, the main cellulose utilizing species are the aerobic and anaerobic hemophilic bacteria, filamentous fungi, basidiomycetes, thermophilic bacteria and actinomycetes (Wright, 2003). At the first step, the microorganisms responsible for cellulose decomposition bring about an enzymatic hydrolysis of the complex polymer, that is, the enzymes system which involves a group of different enzymes, is collectively known as cellulase.

Mainly efficient cellulase activities are observed in fungi but there is increasing interest in cellulase production by bacteria because bacteria have high growth rate as compared to fungi and has good potential to be used in cellulase production. The search for a novel and improved bacterial strain, having hyper cellulase productivity with more activity and high stability against temperature, pH and under non-aseptic conditions might make the process more economical.

The cellulase was first discovered in 1983 from the anaerobic, thermophilic spore-forming *Clostridium thermocellum* (Maki *et al.*, 2011). The production of cellulase generally depends on variety of growth parameters which includes inoculum size, pH value, temperature, presence of inducers, medium additives, aeration, growth and time (Immanuel *et al.*, 2006) and also the cellulase activity is appear to be depend on the presence of various metal ions as activators and inhibitors (Muhammad *et al.*, 2012).

Cellulose is commonly degraded by cellulase. Cellulolytic enzyme system consists of three major components such as endoglucanases, exoglucanases and  $\beta$ -glycosidase. Cellulases have a potentiality to use in biotechnology and in industry such as, starch processing, alcoholic beverage, malting and brewing, clarify of juice, pulp bleaching, textile industry and animal feed (Sreeja *et al.*, 2013).

## **2. MATERIALS AND METHODS**

### **2.1 Collection of Sample**

The soil samples were collected from different areas such as garden soil, soil from different nurseries around Dhaka. Tenfold serial dilutions of each soil sample were prepared in sterilized distilled water and 0.1 ml of that diluted sample was spread on Carboxymethylcellulose medium.

### **2.2 Isolation of Cellulyticbacteria**

Cellulolytic bacterial isolates were isolated from soil by using serial dilutions and pour and spread plate technique. The medium used for isolation of cellulolytic bacteria contains 1.0 % peptone, 1.0 % carboxymethylcellulose (CMC), 0.2 %  $K_2HPO_4$ , 1 % agar, 0.03 %  $MgSO_4 \cdot 7H_2O$ , 0.25%  $(NH_4)_2SO_4$  and 0.2 % gelatin at pH 7 for 48 hours of incubation at 30°C. Bacterial colonies were purified by repeated streaking. The purified colonies were preserved at 4°C for further identification and screening for cellulase production.

### **2.3 Screening of Cellulolytic-bacteria**

Pure cultures of bacterial isolates were individually transferred in CMC agar plates. After incubation for 48 hours, CMC agar plates were flooded with 1 % Congo red and allowed to stand for 15 min at room temperature. One molar NaCl was thoroughly used for counterstaining the plates. Clear zones were appeared around growing bacterial colonies indicating cellulose hydrolysis. The bacterial colonies having the largest clear zone were selected for identification and cellulase production in submerged system.

### **2.4 Identification of Cellulolytic- bacteria**

Identification of cellulolyticbacteria was carried out, which was based on morphological and biochemical tests.

#### **2.4.1Morphological characterization**

Gram stain test was carried out on the bacterial isolates as described in the manual of veterinary laboratory techniques in Kenya (1981). A bacterial smear from a pure culture was prepared and fixed on a clean glass slide. The slide was flooded with crystal violet for 1 minute, and rinsed with running tap water. The slide was then flooded with Gram's iodine for 1 minute, and again rinsed with running tap water. This was followed by decolorization with 95% ethanol and rinsing with tap water. The slide was counter stained with Safranin for 1 minute, rinsed with running tap water and allowed to air dry. The dry slide was covered with immersion oil and viewed under a microscope.

#### **2.4.2 Biochemical characterization**

##### **1) Oxidasetest**

Soak a small piece of filter paper in 1% Kovac's oxidase reagent and let dry.

Use a loop and pick a well-isolated colony from a fresh (18- to 24-hour culture) bacterial plate

and rub onto treated filter paper and observed for color changes. Microorganisms are oxidase positive when the color changes to dark purple within 5 to 10 seconds. Microorganisms are delayed oxidase positive when the color changes to purple within 60 to 90 seconds. Microorganisms are oxidase negative if the color does not change or it takes longer than 2 minutes.

## 2) Catalasetest:

The enzyme catalase converts hydrogen peroxide into water and oxygen, thus helping an organism with toxic O<sub>2</sub> species. The catalase test is used to detect an organism 's ability to produce catalase.

## 3) Indoletest

Indole test is used to determine the ability of an organism to spilt amino acid tryptophan to form the compound indole.

## Methods

- a. Inoculate the tryptophan broth with broth culture or emulsify isolated colony of the test organism in tryptophan broth.
- b. Incubate at 37°C for 24-28 hours in ambient air.
- c. Add 0.5 ml of Kovac's reagent to the broth culture.

## Expected results:

Positive: Pink colored ring after addition of appropriate reagent

Negative: No color change even after the addition of appropriate reagent.

## 4) MR-VPtest

Methyl red test and Voges-Proskauer test both are done in methyl red–Voges-Proskauer (MR-VP) broth, but the reagents that we add differs in terms of reaction.

**Methyl Red (MR) Test:**

- Positive methyl red test were indicated by the development of red color after the addition of methyl red reagent.
- A negative methyl red test is indicated by no color change after the addition of methyl red

**Voges-Proskauer (VP) test:**

1. Negative test is indicated by lack of color change after the addition of Barritt's A and Barritt's B reagents.
2. A positive Voges-Proskauer test is indicated by the development of red-brown color after the addition of Barritt's A and Barritt's B reagents.

**5) Citrate Utilization Test**

Citrate utilization test is performed on Simmons citrate agar:

- A. Negative citrate utilization test is indicated by the lack of growth and color change in the tube
- B. A positive citrate result as indicated by growth and a blue color change.

**6) Carbohydrate Utilization Test**

When carbohydrates are fermented by bacteria, they produce acidic products. A change in pH can be detected when fermentation of a given carbohydrate has occurred. Acids lower the pH of the medium which will cause the pH indicator of Phenol Red to turn Yellow. When bacteria do not ferment the carbohydrate, the media remains red. Sometimes during fermentation, gas is produced. The Durham tube will then have a gas bubble trapped within it. They are the Glucose

(Dextrose) test, Lactose Test and the Sucrose Test. In all of these tests, the bacteria will be inoculated to the medium using a transfer loop. The results obtained will be similar to that illustrated in the picture (Figure 9).



### 7) Motility Utilization Test

Motility utilization test is used to determine whether an organism is equipped with flagella and thus capable of swimming away from a stab mark. The results of motility agar are often difficult to interpret. Generally, if the entire tube is turbid, this indicates that the bacteria have moved away from the stab mark (are motile).

### 8) Nitrate reduction test

This test determines whether the microbe produces the enzymes nitrate reductase and nitrite reductase. The two enzymes catalyze two reactions involved in converting starting compound nitrate into end product nitrogen gas. If a bacterium producing nitrate reductase is grown in a medium containing nitrate, the enzyme converts the nitrate to *nitrite*. *Nitrite* reacts with certain chemicals to yield a red-colored product. If the bacterium also produces *nitrite reductase*, nitrogen gas will be liberated. Bubbles collecting in an inverted Durham tube indicate that nitrogen has been produced.

### 9) Casein Hydrolysis Test

Milk agar contains skim milk (lactose and casein), peptone, and agar. Many organisms can grow on this medium. This medium is used to detect the production of proteases/caseases that digest casein to soluble peptides. This results in a clear zone. Soluble peptides can then be absorbed by the cell. Casein is responsible for the white color of milk. When digested by exoenzymes, the white agar turns clear and colorless. Bacterial pigments can be seen distinctly on this agar.

## 2.4 Inoculums' development

Pure cultures of selected bacterial isolates were individually maintained on CMC supplemented minimal agar slants at 4°C, until used. Pure cultures of selected bacterial isolates were inoculated in broth medium containing 0.03 % MgSO<sub>4</sub>, 0.2 % K<sub>2</sub>HPO<sub>4</sub>, 1 % glucose, 0.25% (NH<sub>4</sub>)<sub>2</sub>SO<sub>4</sub> and

1 % peptone at pH 7 for 24h of fermentation period. After 24h of fermentation period these vegetative cells were used as inoculums source.

### **2.5 Secondary screening and production of cellulose-enzyme:**

The potential isolates were then evaluated for enzyme productivity. Those isolates showing maximum cellulose production were then considered for the further study.

### **2.6 Cellulose enzyme production**

Newly isolated isolates were screened for cellulose enzyme production in submerged fermentation process. Fermentation medium was prepared using 1% potato waste (as cellulose substrate), 0.2%  $K_2HPO_4$ , 0.03 %  $MgSO_4$ , 1 % peptone, 0.25 %  $(NH_4)_2SO_4$  and autoclaved at  $121^\circ C$  for 15min. After sterilization, the medium was allowed to cool at room temperature. The medium was inoculated with 1 ml of selected bacterial isolates and incubated in a shaker at  $35^\circ C$  for 24 h of fermentation period with agitation speed of 140 rpm. After termination of the fermentation period the fermented broth was centrifuged at  $1400\times g$  for 10 min at  $4^\circ C$  to remove

the unwanted material. The clear supernatant thus obtained after centrifugation served as crude enzyme source.

## **2.7 Estimation of cellulose activity**

Cellulase activity was assayed using dinitro-silicic acid (DNS) reagent by estimation of reducing sugars released from CMC solubilized in 0.05 M phosphate buffer at pH 8. The culture broth was centrifuged at  $14000 \times g$  for 10 min at  $4^{\circ}\text{C}$  and the clear supernatant served as crude enzyme source. Crude enzyme was added to 0.5 ml of 1 % CMC in 0.05 M phosphate buffer and incubated at  $50^{\circ}\text{C}$  for 30 min. After incubation, reaction was stopped by the addition of 1.5ml of DNS reagent and boiled at  $100^{\circ}\text{C}$  in water bath for 10 min. Sugars liberated were determined by measuring absorbance at 540 nm. Cellulase production was estimated by using glucose calibration curve. One unit (U) of enzyme activity is expressed as the quantity of enzyme, which is required to release  $1\mu\text{mol}$  of glucose per minute under standard assay conditions.

## **2.8 Optimization of Cultivation Conditions for CMCase Production by the selected isolates-**

The effect of initial pH and temperature on CMCase production was determined by cultivating the strains in medium, same medium used in submerged fermentation at various pH (ranging from 3.0 to 11.0 with an interval of 0.5).

The effect of carbon sources on cellulose production by the strains was determined by using 4 different carbon sources (Filter paper, Cotton, Avielle, CMC). The different carbon sources were used at a concentration of 10 g/L, instead of the core carbon source in the basal medium.

### **2.8.1 Determination of optimum pH for endo-glucanase activity**

The effect of pH on enzyme activity was determined by mixing 500 $\mu$ L of the crude enzyme extract with 500 $\mu$ l substrate at various pH values (1% CMC prepared in 0.05) using sodium phosphate buffer (pH 6.0 to 8.0), sodium citrate (pH 3.0 - pH 6.0) and Glycine-NaOH (pH 9.0-11.0) buffer solutions (Lin *et al.*, 2012). The reaction mixture was incubated in water bath at pre-determined optimum temperature of 98°C for 50 minutes. Amount of glucose produced was assayed by carrying out a DNase test. Using a standard curve, amount of glucose produced was calculated and values obtained used to determine specific enzyme activity.

## **3. RESULTS AND DISCUSSION: -**

### **3.1 Sampling:**

The study was conducted by two soil samples one from National Parliament residential area & another from BRAC nursery.

### **3.2 Isolation of soil bacteria**

Figure (4) showed four isolates were isolated from soil samples collected from National Parliament Residential area & BRAC Nursery. The isolates were treated as different isolates and denoted as NCDB1 - NCDB12 & CDB1 - CDB6 respectively.

A total of 14 cellulose-degrading aerobic bacterial isolates were isolated from different natural reserves in the Dhaka & nearest places of Dhaka, which were cultured in agar medium containing CMC as the sole carbon source.

**Table-3.1** Different locations selected for sample collection to identify cellulose producers.

Site	Sample no	Total no isolate	Labeled as
National Parliament Area	NS1- NS12	12	NCDB1- NCDB12
BRAC Nursery	BS1-BS6	6	CDB1-CDB6

Among the samples, soil sample from national parliament area had shown less clear zone & cellulose activity. The soil sample collected from GOVINDA nursery, showed more cellulose activity so the further study was conducted by using isolates from GOVINDA nursery which are identified as CDB1- CDB6.

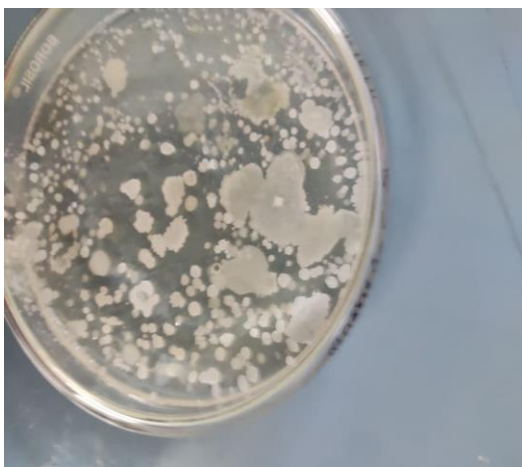

(a)



(b)

**Figure 3.1: Soil Sample from GOVINDA Nursery collected & incubated at 30°C in selected media which is CMC media for 48 hrs.**

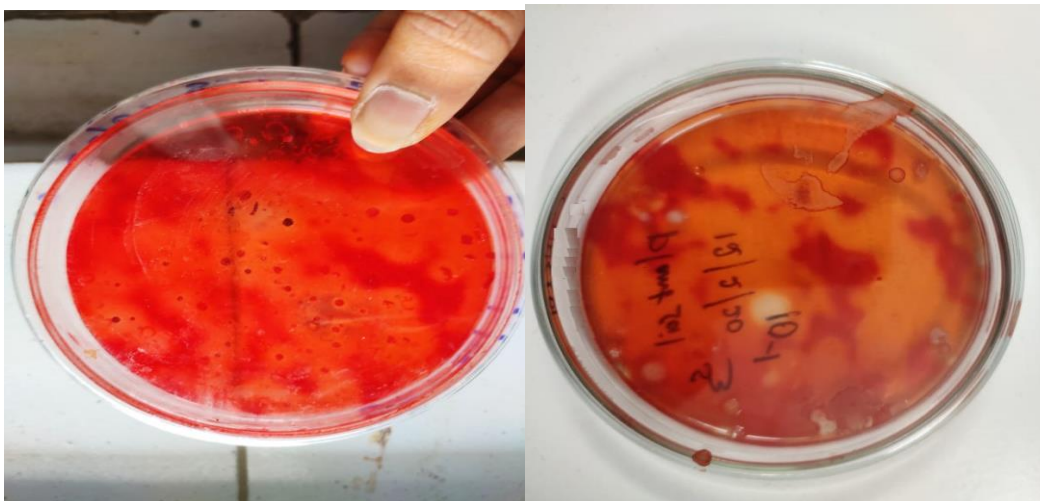

**Figure 3.2: Clear zone was formed after applying Congo red & followed by counter staining NaCl in elected plates for further study.**

Out of these strains, five isolates showed hydrolyzing zones on agar plates containing CMC as core carbon source, after Congo-red staining the hydrolyzing zone diameter and colony diameter were listed & given below in Table 3.

### **3.3 Characterization of bacteria isolates**

#### **3.3.1 Morphological characterization**

The isolates morphological features were determined by Gram stain test. All the isolates retained the purple color of crystal violet stain implying that they were Gram positive rods as shown in Figure 6.

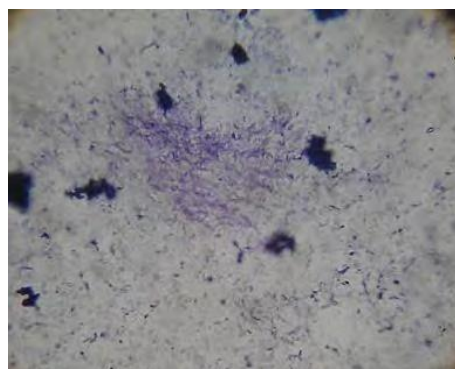
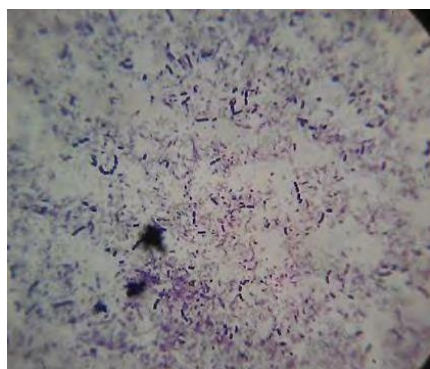



3.3.1.1 (b)

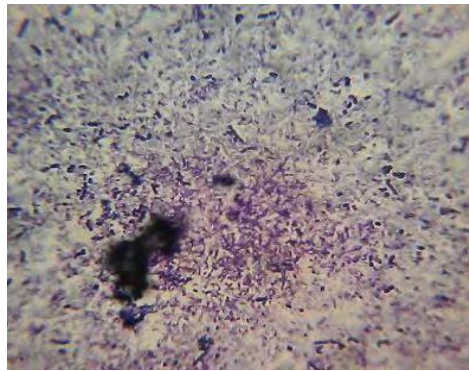

(c)

**Figure 3.3 - Gram staining of CDB3, CDB4, and CDB5 isolates respectively**

In figure 4.3 all three isolates showed positivity in Gram staining test. It indicates that all three isolates are Gram positive (G+) organism.

### 3.3.2 Biochemical characterization:

#### 1. Oxidase test-

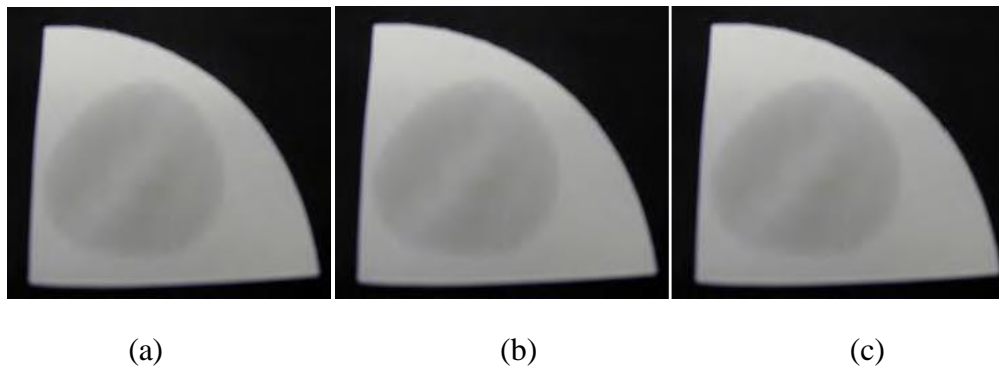

**Figure 4.4- Oxidase test is negative for all three isolates.**

In figure 4.4 showed that there was no color change in filter paper which clearly indicates that all three isolates were oxidase negative.

## 2. Catalase Test



**Figure 3.5: Catalase test is positive for CDB4, CDB5, and CDB6 respectively**

The formation of bubble in figure 4.5 indicated that the isolates were catalase positive and CDB3, CDB4& CDB5 all three isolates were able to produce enzyme catalase &converts hydrogen peroxide into water and oxygen.

## 3. Indole Test

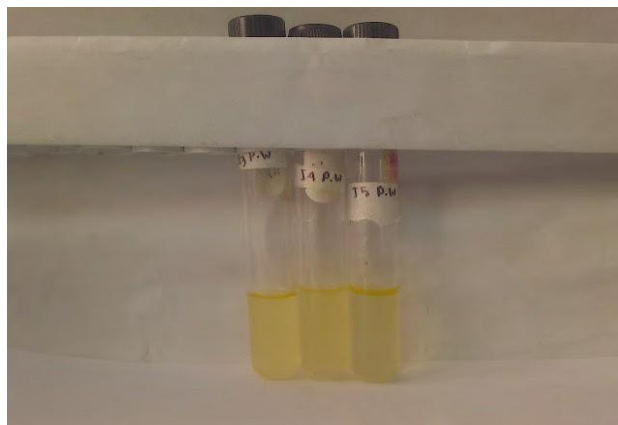

**Figure 3.6: Indole test for CDB3, CDB4 & CDB5**

There was no visible change in the solution showed above in figure 4.6. CDB3, CDB4 & CDB5 all these isolates remain unchanged after incubation which indicated that all these isolates were indole negative.

#### 4. MR-VP



**Figure 4.7: MR-VP test**

In MR-VP test the isolates showed different result as showed in figure 3.7. CDB 5 & CDB 4 changed the color of solution, where CDB3 remain unchanged. So it indicated that CDB5 & CDB4 is positive & CDB3 is negative.

#### 6) Carbohydrate Utilization Test



Glucose



Sucrose

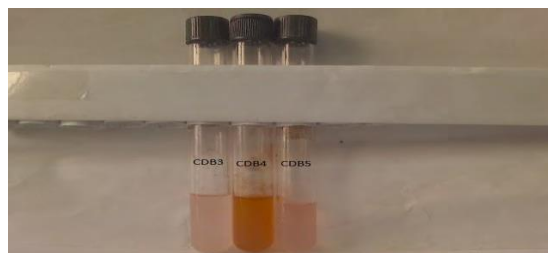

Lactose

**FIGURE 3.8: Carbohydrate utilization test**

In figure 3.8, the results of carbohydrate utilization test is presented. CDB3 produced acid & gas in glucose solution, no acid production in sucrose & no visible change in lactose solution. For CDB4 there was no visible change in glucose solution, in sucrose solution it produces only acid no gas in produced & in lactose solution the result is positive. In CDB5, in glucose solution only acid produced as the color changed while no gas produced, in sucrose solution both acid & gas produced as the color changed & lactose remain unchanged.

**7) MOTILITYTEST****Figure 3.9: Motility test**

Motility test for all three isolates were negative. It declares that isolates were non- motile.

### 8) Nitrate reduction test



**Figure 3.10 - Nitrate reduction test**

This test determines whether the microbe produces the enzymes nitrate reductase and nitrite reductase. In figure 3.10, it showed only CDB 4 is able to produce the enzymes nitrate reductase and nitrite reductase while CDB 3 & CDB 5 was unable to produce the enzymes.

**Table 3.3** - The result of Biochemical test –

Test		CDB3	CDB4	CDB5
Glucose		A,G	NC	A,G-
Sucrose		A <sup>±</sup>	A,G-	A,G+
Lactose		-	+	-
M		-	-	-
I		-	-	-
U		-	-	-
TSI	Slant	A	A	A
	Butt	K	K	A
MR		+	+	-
VP		+	+	-

Oxidase	-	-	-
Catalase	-	+	+
Nitrate	-	+	-

\*Suc=Sucrose, lac=Lactose, Mot= Motility, Ind=Indole, U=Urease, VP= Vogues proskauer

Cit =citrate, Ox=oxidase, Cat = catalase, Nit= nitrite, TSI= triple sugar iron A= acid, AG= acid/

Gas, K= alkaline, NC= Not Countable

#### .Casein Hydrolysis Test:

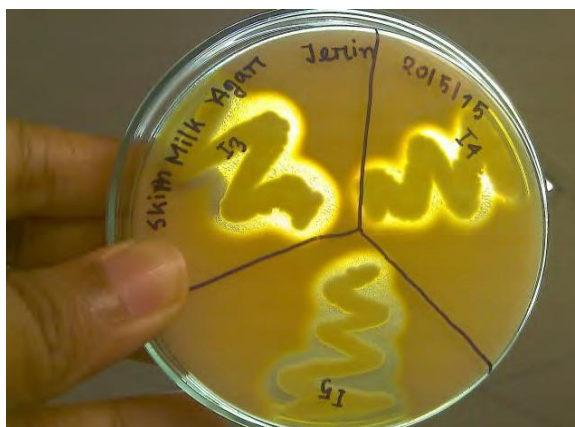

**FIGURE 3.13 –Skim Milk Agar**

In figure 3.13, skim milk agar medium was used to detect the production of proteases/caseases that digest casein to soluble peptides. The clear zone indicated the ability of all three isolates able to produced proteases/caseases& soluble peptides that can then be absorbed by CDB3, CDB4& CDB5.

Five cellulolytic bacterial isolates were obtained from soils excavated from BRAC nursery. The Gram-positive rods were deduced to be *Bacillus acidiceler*(CDB3) ,*Bacillus mycoides*(CDB4) &*Paenibacillusillinoisensis*(CDB5) from both morphological and molecularanalysis.



Crude cellulase mixture from CDB3, CDB4 & CDB5, selected for further studies was shown to bear the two types of cellulolytic activities. From the functional tests carried to determine the optimal conditions for cellulolytic activity, the isolate 's enzyme activity was found to be high over a range of temperatures i.e. from 20°C to 45°C with the optimum temperature being 30°C. Similarly, enzyme activity was found to be high at the range of pH 4 to pH 7 with an optimum of pH 5.5 suggesting that the isolate bears acid cellulases.. Application of these three isolates in industries may have several advantages such as high growth rate and ability to secrete proteins extracellular; features of the *Bacillus* species.

More studies are however needed before industrial application of this isolates. These include enzyme activity assays of the purified specific cellulases for comparison with the results in this study and with those that have been purified. These studies would shed more light on whether to use the whole organism in the industry or harvest the enzymes and carry out downstream processes or purify the gene to know whether the gene is to be added to the genetic pool for protein engineering and directed evolutionary studies to come up with super enzymes. Similar studies should be extended to other environments in the country.

## **BIBLIOGRAPHY: -**

1. Anonymous. (1981). General identification of bacteria. In M. O. Kenya, *Manual of Veterinary Laboratory Techniques in Kenya* (pp. 1-24). Nairobi: Ministry of livestock Development Kenya.
2. Arnold, F. H., Wintrode, P. L., Kentaro, M., &Gershenson, A. (2001, February). How enzymes adapt: lessons from directed evolution. *TRENDS in Biochemical Sciences*, 26(2).
3. Aro, N. A., Saloheimo, Ilme'n, M., &Pentilla, M. (2001). ACEII, a novel transcriptional activator involved in regulation of cellulase and xylanase genes of *Trichodermareesei*. *The Journal of Biological Chemistry*, 276,24309–24314.
4. Atalla, R. H., &Vanderhart, D. L. (1984). Native cellulose: A Composite of two distinct crystalline forms. *Science*, 223(4633), 283-285.

5. Aygan, A., Karcioglu, L., & Arikan, B. (2011). Alkaline thermostable and halophilic endoglucanase from *Bacillus licheniformis* C108. *African Journal of Biotechnology*, 10 (5), 789-796.
6. Bagnara, C., Gaudin, C., & Be'lar'ch, J. P. (1987). Physiological properties of *Cellulomonas fermentans*, a mesophilic cellulolytic bacterium. *Applied Microbiology and Biotechnology*, 26, 170–176.
7. Benitez, T., Limon, C., Delgado-Jarana J, J., & Rey, M. (1998). Glucanolytic and other enzymes and their genes. In G. F. Harman, & C. P. Kubicek, *Trichoderma & Gliocladium—Enzymes, biological control and commercial applications* (Vol. 2, pp. 101–127). London, UK: Taylor & Francis.
8. Bhat, M. K. (2000). Cellulases and related enzymes in biotechnology. *Biotechnology Advances*, 18, 355-383.
9. Caltech. (2009, 032009 23). 15 new highly stable enzyme catalysts that efficiently breakdown cellulose into sugars at high temperatures. Retrieved from <http://www.caltech.edu/content/caltech-scientists-create-new-enzymes-biofuel-production#sthash.1rH2qAnU>
10. Camassola, M., De BittenCourt, L. R., Shenem, N. T., Andraus, J., & Dillon, A. J. (2004). Characterization of the cellulose complex of *Penicillium chitinatum*. *Biocatalysts Biotransformation*, 22, 391-396.
11. Clemmer, J. E., & Tseng, C.-L. (1986). Identification of the major anaerobic end products of *Cellulomonas sp.* (ATCC 21399). *Biotechnology Letters*, 8(11), 823-826.
12. Cooney, C. L., Wang, D. I., Wang, S. D., Gordon, J., & Jiminez, M. (1978). Simultaneous cellulose hydrolysis and ethanol production by a cellulolytic anaerobic bacterium. *Biotechnol, Bioengineering symp*, 8, 103-114.
13. D'Amico, S., Collins, T., Marx, J., Feller, G., & Gerday, C. (2006, April). Psychrophilic microorganisms: challenges for life. *EMBO Reports*, 7(4), 385–389.
14. Dashtban, M., Maki, M., Tin Leung, K., Mao, C., & Qin, W. (2010). Cellulase activities in biomass conversion: measurement methods and comparison. *Critical Reviews in Biotechnology*, 1–8.

15. Demirbas, A. (2008). Biofuels sources, biofuel policy, biofuel economy and global biofuel projections. *Energy Conversion and Management*, 49(8), 2106–2116.
16. Dutta, T., Sahoo, R., Sengupta, R., Ray, S. S., Bhattacharjee, A., & Ghosh, S. (2008). Novel cellulases from an extremophilic filamentous fungi *Penicillium citrinum*: production and characterization. *Journal of industrial microbiology and biotechnology*, 35, 275–282.
17. Edgar, R.C. (2004) MUSCLE: Multiple Sequence alignment with high accuracy throughput. *Nucleic acids Res.* 32(52), 1792-1797.
18. Eijsink, V., Gåseidnes, S., Borchert, T., & Burg, V. d. (2005, June). Directed evolution of enzyme stability. *Biomolecular Engineering*, 22(1-3), 21-30.
19. Fenington, G., Lupo, D., & Stutzenberger, F. (1982). Enhanced cellulase production in mutants of *Thermomonospora curvata*. *Biotechnol Bioengineering*, 24, 2487-2497.
20. Fierobe, H. P., Bayer, E. A., Tardif, C., Czjzek, M., Mechaly, A., Belaich, A., Lamed, R., Shoham, Y. (2002). Degradation of cellulose substrates by cellulosome chimeras. Substrate targeting versus proximity of enzyme components. *The Journal of Biological Chemistry*, 277, 49621–49630.
21. Flengsrud, A. R., Lindahl, V., & Tronsomo, A. (1994). Characterization of production and enzyme properties of an endo 1-4 glucanase from *Bacillus subtilis* CK-2 isolated from compost soil. *Antonie Van Leeuwenhoek*, 66, 319-326.
22. Godden, B., & Penninckx, M. (1984). Identification and evolution of the cellulolytic microflora present during composting of cattle manure: On the role of *Actinomycetes* Sp. *Annales de l'Institut Pasteur Microbiologie*, 135(1), 69-78.
23. Grassin, C., & Fauquembergue, P. (1996a). Fruit juices. In T. Godfrey, & S. West, *Industrial enzymology* (pp. 226–240). UK: Macmillan.
24. Gunata, Y. Z., Bayonove, C. L., Cordonnier, R. E., & Arnaud, A. G. (1990). Hydrolysis of grape monoterpenyl glycosides by *Candida molischiana* and *Candida wickerhamii*  $\alpha$ -glucosidases. *Journal of the Science of Food and Agriculture*, 50, 499–506.
25. Liszka, M. J., Clark, M. E., Elizabeth, S., & Clark, D. S. (2012). Nature Versus Nurture: Developing Enzymes That Function Under Extreme Conditions. *Annual review of chemical and biomolecular engineering*, 3, 77–102.
26. Pakula, N. A., & Penttila, M. (2005). Transcriptional regulation of Plant Cell Wall Degradation By Filamentous Fungi. *FEMS Microbiology Reviews*, 29(4), 719-739.

27. Pommier, J. C., Goma, G., Fuentes, J. L., Rousset, C., & Jokinen, O. (1990). Using enzymes to improve the process and the product quality in the recycled paper industry. Part 2: industrial applications. *Tappi Journal*, 73, 197–202.
28. Rapp, P., & Beerman. (1991). Bacterial cellulases. In C. H. Weimer, *Biosynthesis and degradation of cellulose* (pp. 535-595). New York: Marcel Dekker .
29. Richardson, T. H., Tan, X., Frey, G., Callen, W., Cabell, M., Lam, D., Macomber, J., Short, J. M., Robertson, D. E., Miller, C. (2002, July 19). A novel, high performance enzyme for starch liquefaction. Discovery and optimization of a low pH, thermostable alpha-amylase. *Journal of Biological Chemistry*, 277(29), 26501-26507.
30. Robertson, D. E., & Steer, B. A. (2004, April). Recent progress in biocatalyst discovery and optimization. *Current Opinion in Biotechnology*, 8(2), 141-149.
31. Robson, L. M., & Chambliss, G. H. (1984). Characterization of the cellulolytic activity of a Bacillus isolate. *Applied and environmental microbiology*, 1039-1046.
32. Tatsumoto, K., Baker, J. O., Tucker, M. P., O, M. P., Mohagheghi, A., Grohmann, K., & Himmel, M. E. (1988, August ). Digestion of Pretreated Aspen Substrates. *Applied Biochemistry and Biotechnology*, 18(1), 159-174.
33. Vaheri, M., Leisola, M., & Kaupinnen, V. (1979). Transglycosylation products of cellulase system of *Trichoderma reesei*. *Biotechnology Letters*, 1, 41–46.
34. Vieille, C., & Zeikus, G. J. (2001). Hyperthermophilic enzymes: sources, uses, and molecular mechanisms for thermostability. *Microbiology and Molecular Biology Reviews*, 65(1), 1-43.
35. Wang, M., Saricks, C., & Santini, D. (1999). *Effects of Fuel Ethanol Use on Fuel-Cycle Energy and Greenhouse Gas Emissions*. The University of Chicago, Center for Transportation Research Argonne National Laboratory. Argonne's Information.
36. Wang, L. J., Kong, X. D., Zhang, H. Y., Wang, X. P., & Zhang, J. (2000). Enhancement of the activity of L-aspartase from *Escherichia coli* W by directed evolution. *Biochemical and Biophysical Research Communications*, 276 (1), 346-349.
37. Warren, R. A. (1996). Microbial hydrolysis of polysaccharides. *Annual Review of Microbiology*, 50, 183–212.
38. Wenzel, M., Schonig, I., Berchtold, M., Kampfer, P., & Konig, H. (2002). Aerobic and facultatively anaerobic cellulolytic bacteria from the gut of the termite  
Wilson, J. R. (1993). Organization of forage plant tissues. In H. G. Jung, D. R. Buxton, R. D.

Hatfield, & J. Ralph, *Forage cell wall structure and digestibility* (pp. 1–32). Madison, USA: Agronomy—Crop Science Society of America—Soil Science Society of America.

**39.** Wood, & Bhat. (1988). Methods for measuring cellulase activities. *Method. Enzymol*, 160, 87-117.

**40.** Wu, B., Zhao, Y., & Gao, P. J. (2006). A new approach to measurement of saccharifying capacities of crude cellulases. *BioResources*, 1(2), 189-200.

---

**INTERNATIONAL RESEARCH JOURNAL OF SCIENCE  
ENGINEERING AND TECHNOLOGY**

ISSN 2454-3195

*An Internationally Indexed Peer Reviewed & Refereed Journal*



**Shri Param Hans Education &  
Research Foundation Trust**

**WWW.RJSET.COM  
www.SPHERT.org**

Published by iSaRa Solutions



## A Review on Human and Environmental impacts due to LEAD Toxicity

**Dasika Ravikumar \* JLSS Phani Kumar \*\***

Bhupathi Raju Vissam Raju College , Vishnupur, Bhimavaram, West Godavari District,  
Andhrapradesh-534202

**Abstract:** Lead is virtually immobile, does not break down in the environment; if left undisturbed and is a heavy metal that occurs naturally in the Earth's crust. Lead moves into and throughout ecosystems. Atmospheric lead is deposited in vegetation, ground and water surfaces. Lead bioaccumulation, nondegradability, and the excessive amounts in which they exist, contaminate the food chain and subsequently become a source of toxicity to human beings and the entire ecological function. The chemical and physical properties of lead and the biogeochemical processes within ecosystems will influence the movement of lead through ecosystems. Lead can also cause hemolytic anemia due to disruption of the cellular membrane by lipid per oxidation. Lead toxicity also affects neurotransmitter levels and causes severe health issues related to organ damage, some even leading to death. The main aim of this review article is to summarize lead toxicity detection, its sources, and its mechanism including various toxicological effects on human health. Lead is highly persistent in the environment and because of its continuous use its levels rise in almost every country, posing serious threats. Low blood lead levels are sufficient to inhibit the activity of these enzymes and induce generation of reactive oxygen species and intensification oxidative stress. Oxidative stress plays important role in pathogenesis of lead-induced toxicity and pathogenesis of coupled disease.

**Key words:** lead toxicity, exposure, Health Impacts, toxicological effects

### **Need of Review:**

Science is constantly refining and increasing and never static in nature as the process of scientific research and exploration is dynamic to the core. This will become extra relevant inside the present day landscape of science while there is an explosion of know-how sharing of records is sort of immediate. Heavy metals are abundant in the environment and contribute largely to the sustainability and equilibrium of ecosystem processes. Emerging statistics often not pertains to molecular mechanism of lead toxicity but it contains the interplay between lead compounds and molecules engaged in biological pathways of cell protection, DNA replication, Protein synthesis, regulation of cellular multiplication and apoptosis. For this reason, I felt that various vital aspects of lead toxicity needs be up reviewed which offer the outline of the hassle that could be a global environmental situation.

**Introduction:** Lead is the most important toxic heavy element in the environment. It's important physico-chemical properties, utilized to retracing the historical times. It is an abundantly distributed globally, yet a dangerous environmental chemical (Mahaffay, [1990](#)). Its important properties like softness, malleability, ductility, poor conductivity and resistance to corrosion seem to make difficult to give up its use. Due to its non-biodegradable nature and continuous use, its concentration accumulates in the environment with increasing hazards. The metal can

affect all components of the environment and can move through the ecosystem until it reaches equilibrium. Lead accumulates in the environment, but in certain chemical environments it will be transformed in such a way as to increase its solubility (e.g., the formations of lead sulfate in soils), its bioavailability or its toxicity. The effects of lead at the ecosystem level are usually seen as a form of stress (US EPA 1991).

In general, there are three known ways in which lead can adversely affect ecosystems. Populations of micro-organisms may be wiped out at soil lead concentrations of 1,000 parts per million (ppm) or more, slowing the rate of decomposition of matter. Populations of plants, micro-organisms and invertebrates may be affected by lead concentrations of 500 to 1,000 ppm, allowing more lead-tolerant populations of the same or different species to take their place. This will change the type of ecosystem present. At all ambient atmospheric concentrations of lead, the addition of lead to vegetation and animal surfaces can prevent the normal bio-chemical process that purifies and repurifies the calcium pool in grazing animals and decomposer organisms (UNEP 1989).

Lead and its compounds expose to humans mostly in lead related occupations with various sources like leaded gasoline, industrial processes such as smelting of lead and its combustion, pottery, boat building, lead based painting, lead containing pipes, battery recycling, grids, arm industry, pigments, printing of books, *etc.* In car engines lead is burned, so that lead salts (chlorides, bromides, and oxides) will originate. Lead is one out of four metals that have the most damaging effects on human health (Tiwari Seema and Tripathi 2012).

Widespread use has been discontinued in many countries of the world it is still used in many industries like car repair, battery manufacturing and recycling, refining, smelting, *etc.* Lead is a highly poisonous metal affecting almost every organ in the body. Nervous system is the mostly affected target in lead toxicity, both in children and adults. However toxicity in children has a greater impact than in adults, due to their tissues, internal as well as external, are softer than in adults. To even low levels of lead, Infants and young children are especially sensitive which may contribute to behavioral problems, learning deficits and lowered IQ (Rubin & Strayer, 2008).

**Sources of lead pollution:** In India may be divided into two major categories: Industrial and domestic. The industrial lead exposures are mainly due to the particulates generated by coal burning and roasting of minerals i.e. iron pyrites, dolomite, alumina *etc.* The domestic lead exposures come mainly from cooking by use of the solid fuels (i.e. coal, biomass, agriculture waste, *etc.*), paints, and ceramic glazes, cosmetic and folk remedies, drinking water and food, *etc.* Increase amount of lead creates measure environmental health problem in India. Lead is a potent poison and is harmful in even very small amount. Lead is an important environmental contaminant because of its known toxicity to humans and other living organisms. Lead is one of a limited class of elements that can be described as purely toxic. Many other elements, including heavy metals such as chromium, manganese, molybdenum, nickel, and selenium, although toxic at high levels, are actually required nutrients at lower levels. This is clearly not the case for lead. Lead is a relatively corrosion resistant, dense and malleable metal that has been used by humans for at least 5000 years. During this time, lead pollution has increased from an estimated 10 tons per year to 1,000,000 tons per year, accompanying population and economic growth (Davidson, C.L., Rabinowitz, 1992).

### Sources of Lead Exposure

Lead is a heavy metal that is both poisonous and a ubiquitous environmental toxicant. It is environmentally distributed in three forms: Metallic lead, lead salts, and organic lead containing carbon (Assi MA, Hezmee MNM, Haron AW, Sabri MY, Rajion, 2016). Sources of lead exposure include mainly industrial processes, food and smoking, drinking water and domestic sources. The sources of lead were gasoline and house paint, which has been extended to lead bullets, plumbing pipes, pewter pitchers, storage batteries, toys and faucets (Thürmer *et al.*, 2002).

Manufacturing the products of Lead industrially can result in human occupational exposure mainly in the production of lead-acid batteries, plumbing materials, alloys and in cable sheathing, paints, glazes and ammunition UNEP (2010), WHO (2017). Occupational exposure can also occur during the application and removal of lead-containing paints; during the grinding, welding and cutting of materials coated with lead-containing paints, such as in shipbuilding, construction and demolition industries; and in the fabrication and carving of lead crystal glassware UNEP (2010). Mining, smelting, and formal and informal processing and recycling of electric and electronic waste can also be significant sources of exposure. Disposed of lead-corrosive batteries are the most widely recognized source of lead harming in ruminants; the lead constantly salts in batteries are promptly eaten by animals. There are numerous potential sources including polluted feed or soil, plumbing patch, lead shot, oil, disposed of black-top,

In the atmosphere, lead will deposit on surfaces or exist as a component of atmospheric particles. In the atmosphere, lead exists primarily as lead compounds. The residence time ranges from hours to weeks. Transport of atmospheric lead is linked to the characteristics of aerosols.

In the aquatic environment, lead can occur in ionic form (highly mobile and bio-available), organic complexes with dissolved humus materials (binding is rather strong and limits availability), attached to colloidal particles such as iron oxide (strongly bound and less mobile when available in this form than as free ions) or to solid particles of clay or dead remains of organisms (very limited mobility and availability). The speciation of lead differs in fresh water and seawater: in fresh water, lead primarily exists as the divalent cation ( $Pb^{2+}$ ) under acidic conditions, and forms  $PbCO_3$  and  $Pb(OH)_2$  under alkaline conditions. Lead speciation in seawater is a function of chloride concentration and the primary species are  $PbCl_3^- > PbCO_3 > PbCl_2 > PbCl^+ >$  and  $Pb(OH)^+$ . In surface waters, average residence times of biological particles containing lead have been estimated at two to five years.

Human exposure to lead can occur in a variety of ways, all of which involve environmental pollution. Lead enters the body via ingestion or inhalation from sources such as soil, food, lead dust and contact with lead in products of everyday use and in the workplace (Figure 1). In the work environment, the main route of absorption of Pb and its compounds is through the respiratory system, although lead is also absorbed via the digestive system (Spivey, (2007); ATSDR, (2019).

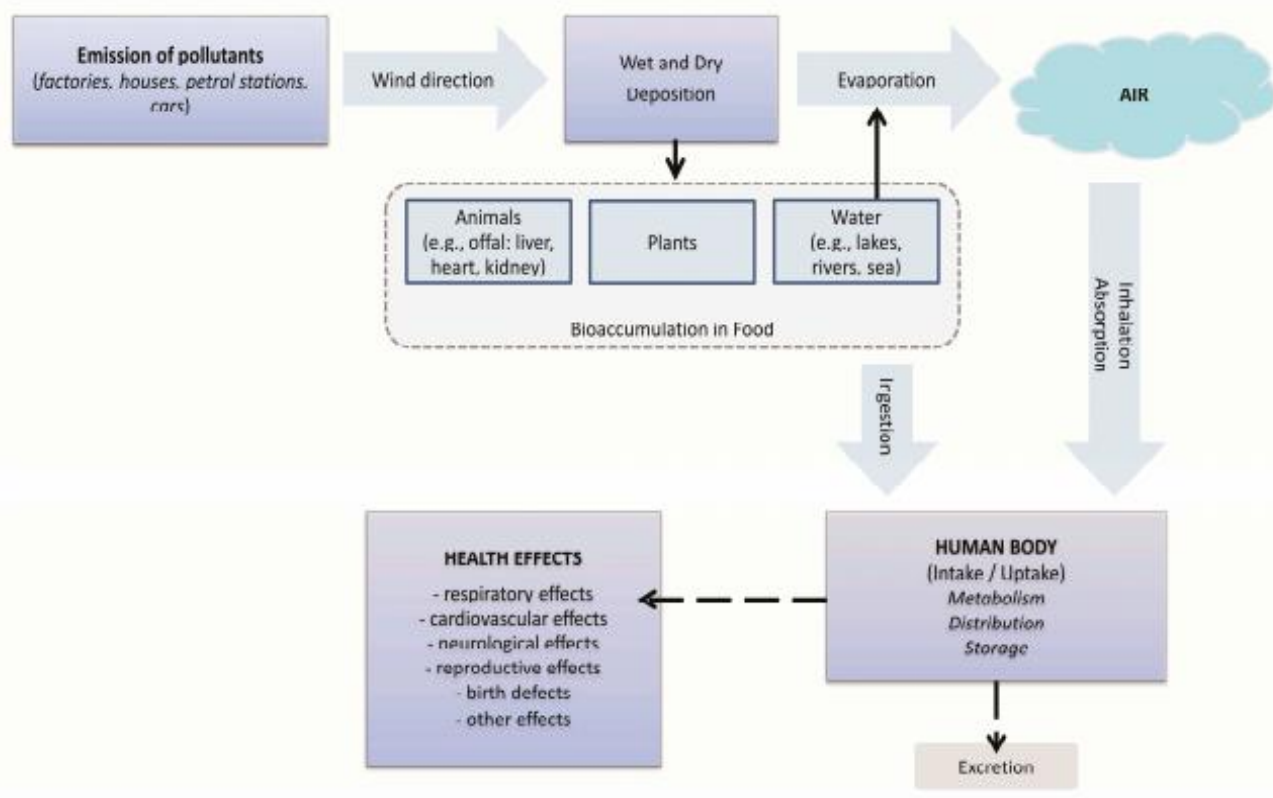

Figure 1. Exposure to lead pollution and possible health effects in humans (Adopted from: [2]).

Figure1: Exposure to lead pollution and possible health effects in humans (Adopted from Wani, et al 2015).

Table 1: Summary of sources of lead exposure		
Sources of lead poisoning	Reason for poisoning	Citations
Lead in paint	Old buildings built before 1978 used lead-based paint	(Ferguson, 2013)
Lead in dust	Interior house dust contaminated with lead	(Gould, 2009)
Lead in water	Old well pumps still in operation contaminating lead	(EPA, 2017)
Lead in tableware	Old or poorly glazed ceramic dishes, pewter, brass, and pottery may contain lead	(floridahealth.gov, 2017)
Lead in soil	Mixed lead-based paint with soil Lead also mixed with soil from mainly metal smelting and battery manufacturing factory	(health.ny.gov, 2017)
Lead in folk medicines and cosmetics	Some folk medicines greta, azarcon, and pay-loo-ah contained lead Some cosmetics such as surma, kohl (alkohl), kajal, tiro, and tozali also contained lead	(health.state.mn.us, 2017)

Lead in occupational sources	Regularly working equipment (radiation protector, some surgical tools, developing dental X-ray films processing to digital X-rays, and electronic fetal monitors) that involves lead-containing products	(health.state.mn.us, 2017)
Lead in metal	costume jewelry Metal costume jewelry (charm jewelry, costume jewelry, trinkets, and fashion jewelry) containing lead	( <a href="https://www.ceh.org/campaigns">https://www.ceh.org/campaigns</a> , 2017)
Lead in toys	Toys and other useful goods for children found high range of lead	( <a href="https://www.injury.findlaw.com">https://www.injury.findlaw.com</a> 2017)

**Methods and Data:** To achieve the objectives of this review, the authors conducted a structured search process to identify the body of the current literature relevant to the study. In collecting relevant literature, the authors ensured that they maintained quality and academic standard, which are often the basis of most literature review studies, for example, (onemann and Schumann (2018). Therefore, the present literature search considered mainly research articles published in highly reputed journals (indexed by Scopus and Scimago and ranked in (Thompson Reuter). . The study also considered several other libraries including DOAJ (Directory of Open Access Journals) digital Library, Google Scholar, PubMed, E-resources, IEEE Explore, SpringerLink, ScienceDirect, and (Thomson Reuters' Web of Science. Key terms such as "heavy metals," "food chain," and "food poisoning".

**Storage of Lead in the Body:** Lead is stored in the bones (Fernando, 2005) where it is not uniformly distributed and tends to accumulate in bone regions undergoing the most active calcification at the time of exposure. Accumulation occurs mainly in the trabecular bone during childhood and in the cortical bone in adulthood. Bone-to-blood lead mobilization increases with age, broken bones, chronic disease, hyperthyroidism, kidney disease, pregnancy and lactation, menopause and physiologic stress. Lead can be mobilized during these periods: (Agency for Toxic Substances and Disease Registry.2017)

- Pregnancy and lactation
- Periods of physiologic stress
- Chronic disease including hyperthyroidism and kidney disease
- Broken bones
- Menopause
- Advanced age

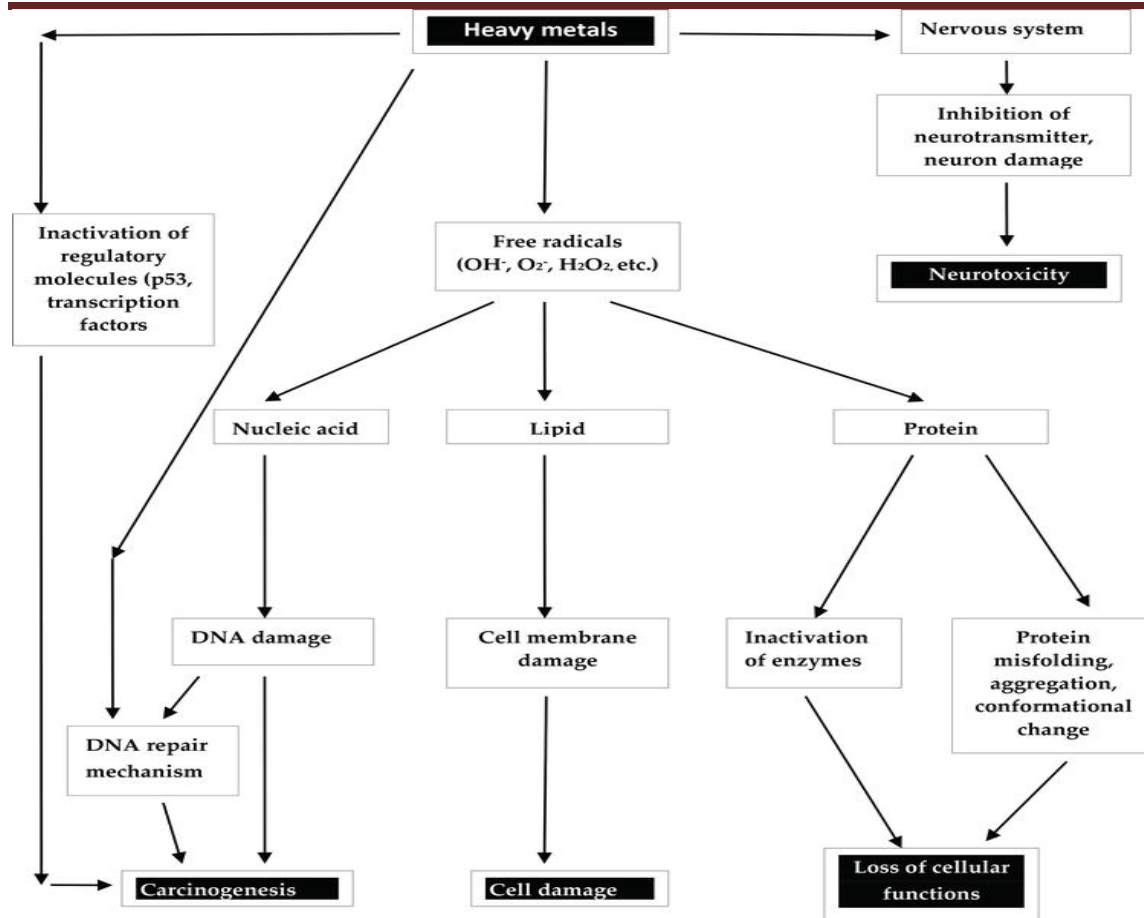

**Figure 2:** Pathway of heavy metals sources and exposure to humans.

**Vulnerable Populations are Fetus, Infant and Child:** Damage causes to the developing brain and nervous system, the fetus and child are more sensitive to lead exposures than adults. Children are more sensitive to lead's impacts, with health effects at lower blood lead levels than adults. A developing fetus can be greatly affected from exposures too low to cause health issues for the mother (Agency for Toxic Substances & Disease Registry, 2016).

Boiling water does not remove lead hazards and may even increase the concentration of lead in the water. However, a variety of methods are available for reducing lead in tap water such as: Reverse osmosis filters, Distiller, Under sink filters, Countertop filters, Faucet filters (Minnesota Department of Health, 2010)

### Health Impacts of Lead

Even at very low doses, lead toxicity can impact several systems in the human body (Agency for Toxic Substances & Disease Registry, 2016)

- Gastrointestinal, including severe cramping and abdominal pain at higher exposures
- Cardiovascular, contributing to the onset and development of hypertension, plus coronary artery disease, peripheral vascular disease, atherosclerosis, stroke, myocardial infarction (heart attack) and arrhythmias
- Reproductive, affecting sperm, fertility, time to sexual maturation, menstrual disorders and pregnancy outcomes including miscarriage, stillbirth and reduced fetal growth. In addition, lead can result in delayed growth in children.



- Renal, including chronic advanced renal disease or impaired renal function
- Hematological, inhibiting the body's ability to make hemoglobin and thereby causing anemia
- Endocrine, impeding the body's ability to convert vitamin D into its hormonal form
- Vision, causing cataracts
- Musculoskeletal, causing gout
- Immune, associated with immune suppression
- Nervous, the most sensitive target of lead exposure, this system includes the brain. Neurological effects are covered in more detail in the table below.

According to Martin & Griswold, 2009, toxicity of lead, also called lead poisoning, can be either acute or chronic. Acute exposure can cause loss of appetite, headache, hypertension, abdominal pain, renal dysfunction, fatigue, sleeplessness, arthritis, hallucinations and vertigo. Acute exposure mainly occurs in the place of work and in some manufacturing industries which make use of lead. Chronic exposure of lead can result in mental retardation, birth defects, psychosis, autism, allergies, dyslexia, weight loss, hyperactivity, paralysis, muscular weakness, brain damage, kidney damage and may even cause death. Brochin et al., 2008 reported in his studies that environmental and domestic sources of lead ions are the main cause of the disease.

Kosnett, 2006; well studied the effects of lead at cellular level were able to create reactive radicals which damage cell structures, including DNA and cell membrane. It also interferes with the enzymes that help in the synthesis of vitamin D and with enzymes that maintain the integrity of the cell membrane and even with DNA transcription. The effects were explained and showed in [Figure 3](#).

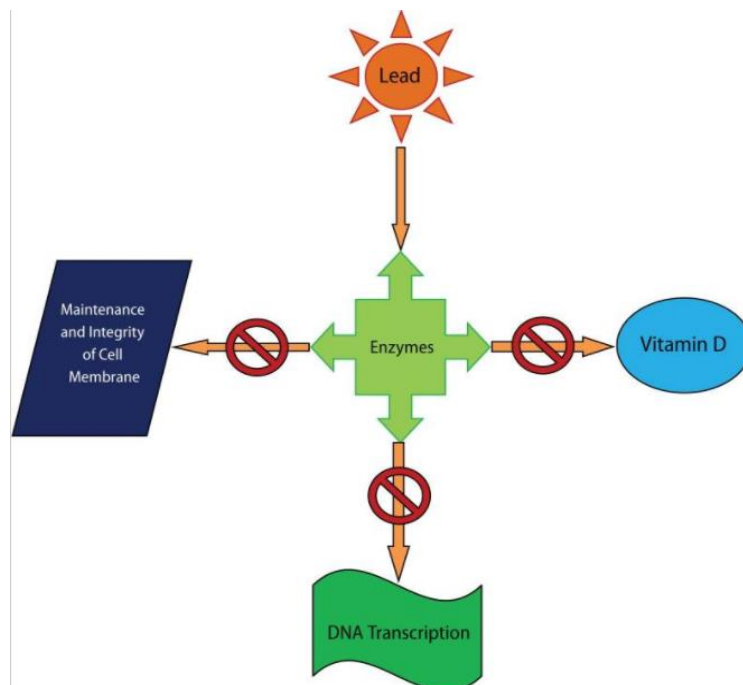

[Figure 3](#) Illustration of the action of lead on enzymes, leading to the disruption of vitamin D synthesis, maintenance of cell membrane and DNA transcription. One of the main reasons for is that lead

Patrick *et al.*, [2006](#) and Fujita *et al.*, [2002](#) reported that lead poisoning causing anaemia is due to the interference of lead with the activity of an essential enzyme called delta-aminolevulinic acid dehydratase, or ALAD, which is important in the biosynthesis of heme, the cofactor found in haemoglobin.

Dart *et al.*, [2004](#) stated that the blood lead levels in mothers and infants are usually similar as the lead present in mother blood passes into the fetus through the placenta and also through breast milk.

Navas-Acien *et al.*, [2007](#) stated that general morphology of sperm and activities like motility are also affected and Park *et al.*, [2008](#) studies reported that reproductivity of females due to lead exposure are more severe and causes miscarriages, prematurity, low birth weight, and problems with development during childhood.

Zhang *et al.* ([2014](#)), recently studied that lead interactions with human chorionic gonadotropin (HCG) HCG was investigated by UV-vis absorption spectroscopy, circular dichroism spectroscopy, and ELISA indicated that lead acetate changed the secondary structure of HCG by loosening and destruction of the HCG skeleton and by increasing the hydrophobicity around Tyr residues, which resulted in decreased bioactivities of HCG.

**Conclusion:** Lead poisoning causes severe effects and is a matter of serious concern, yet importantly, can be preventable. Best approach is to avoid any possible exposure to lead and can be achieved by identification of the lead sources in the environment and continued public health initiatives to remove lead from the environment. The most dangerous effects occur in the central and peripheral nervous systems, the hematopoietic system, the cardiovascular system and in some organs such as the liver and kidneys. Social and professional education should promote lead awareness, increase health knowledge and provide the skills necessary to prevent lead poisoning. Antioxidants, especially vitamin C, are used for the treatment and improvement of oxidative stress-induced toxicity of lead until now. Lead toxicity can be reduced by creating health awareness, and timely medical treatment.

**References:**

1. UNEP/WHO/ILO: Environmental Health Criteria No.85: Lead—Environmental Aspects, 1989
2. U.S. Environmental Protection Agency. (1993) “Studies of the Lead Problem in Paint, Dust, and Soil,” Office of Pollution Prevention and Toxics, Washington, D.C.
3. Mahaffey KR. Environmental lead toxicity: nutrition as a component of intervention. *Environ Health Perspect.* 1990;89:75–78. 4
4. Rubin R, Strayer DS. Rubins pathology; *Clinicopathologic Foundations of Medicine.* 5th ed. Lippincot Williams & Wilkins; 2008. Environmental and Nutritional pathology.
5. Tiwari Seema and Tripathi I.P, Lead Pollution -An Overview, *Int. Res. J. Environment Sci.*, 1(5), 84- 86, 2012.6.
6. Davidson, C.L., Rabinowitz, M., Lead in the Environment, from sources to human receptors, In: Needleman H .ed. *Human Lead Exposure.* Boca Raton, F L: CRC Press; (1992)
7. Spivey, A. The Weight of Lead: Effects Add Up in Adults. *Environ. Health Perspect.* 2007, 115, 30–36. [CrossRef]

8. ATSDR. Lead Toxicity: Case Studies in Environmental Medicine (CSEM). Environmental Health and Medicine Education. 2017. Available online: [https://www.atsdr.cdc.gov/csem/lead/docs/CSEM-Lead\\_toxicity\\_508.pdf](https://www.atsdr.cdc.gov/csem/lead/docs/CSEM-Lead_toxicity_508.pdf) (accessed on 12 June 2019).
9. Assi MA, Hezmee MNM, Haron AW, Sabri MY, Rajion MA. The detrimental effects of lead on human and animal health. *Veterinary World*. 2016; 9(6): 660-671
10. Wani, A.L.; Ara, A.; Usmani, J.A. Lead toxicity: A review. *Int. Toxicol.* 2015, 8, 55–64.
11. Fernando, B., Jr.; Tanus-Santos, J.E.; Gerlach, R.F.; Parsons, P.J. A Critical Review of Biomarkers Used for Monitoring Human Exposure to Lead: Advantages, Limitations, and Future Needs. *Environ. Health Perspec.* 2005, 113, 1669–1674.
12. Thürmer K, Williams E, Reutt-Robey J. Autocatalytic oxidation of lead crystallite surfaces. *Science*. 2002; 297(5589):2033–2035.
13. Lead Poisoning in Children: Early Detection, Intervention and Prevention; 2017. Available from: <http://www.health.state.mn.us/divs/fh/mch/webcourse/lead/>. [Last accessed on 2017 Oct 19].
14. Lead Contaminated Soil. Available from: <http://www.health.state.mn.us/divs/eh/lead/homes/worksoil.html> () [Last accessed on 2018 Dec 23]
15. How Can We Make Our Homes Healthier? Available from: [http://www.hec.uconn.edu/documents/HealthyHomes\\_HealthyKids.pdf](http://www.hec.uconn.edu/documents/HealthyHomes_HealthyKids.pdf). [Last accessed on 2017 Oct 20].
16. Gould E. Childhood lead poisoning: Conservative estimates of the social and economic benefits of lead hazard control. *Environ Health Perspect* 2009;117:1162-7.
17. Dhimal M, Karki KB, Aryal KK, Dhimal B, Joshi HD, Puri S, et al. Correction: High blood levels of lead in children aged 6-36 months in Kathmandu Valley, Nepal: A cross-sectional study of associated factors. *PLoS One* 2017;12:e0185773.
18. Basic Information about Lead in Drinking Water. Available from: <https://www.epa.gov/ground-water-and-drinking-water/basic-information-about-lead-drinking-water>. [Last accessed on 2017 Oct 20].
19. Lead Poisoning. Available from: [https://www.en.wikipedia.org/wiki/Lead\\_poisoning](https://www.en.wikipedia.org/wiki/Lead_poisoning). [Last accessed on 2017 Dec 22].
20. Possible Sources of Lead Exposure. Available from: [http://www.floridahealth.gov/environmental-health/lead-poisoning/\\_documents/oregon-lead-sources.pdf](http://www.floridahealth.gov/environmental-health/lead-poisoning/_documents/oregon-lead-sources.pdf). [Last accessed on 2017 Oct 22].
21. Sources of Lead. Available from: <https://www.health.ny.gov/environmental/lead/sources.htm>. [Last accessed on 2017 Oct 22].
22. Unusual Sources of Lead Poisoning. Available from: <https://www.poison.org/articles/2011-dec/unusual-sources-of-lead-poisoning>. [Last accessed on 2017 Oct 23]
23. Lead in Toys and Lead Poisoning in Children. Available from: <https://www.injury.findlaw.com/product-liability/lead-in-toys-and-lead-poisoning-in-children.html>. [Last accessed on 2017 Oct 26].
24. Lead in Toys. Available from: <https://www.ceh.org/campaigns/legal-action/previous-work/childrens-products/lead-in-toys/>. [Last accessed on 2017 Oct 26].

25. N. (onemann and M. Schumann, "Environmental impacts of wood-based products under consideration of cascade utilization: a systematic literature review," *Journal of Cleaner Production*, vol. 172, pp. 4181–4188, 2018
26. UNEP (2010). Final review of scientific information on lead. Nairobi, United Nations Environment Programme, Chemicals Branch (<https://www.unenvironment.org/es/node/24587>).
27. WHO (2017). Recycling used lead-acid batteries: health considerations. Geneva, World Health Organization (<https://apps.who.int/iris/handle/10665/259447>).
28. Agency for Toxic Substances & Disease Registry. [Lead Toxicity: What Are the Physiologic Effects of Lead Exposure?](#) August 25, 2016.
29. Minnesota Department of Health. [Point-of-Use Water Treatment Units for Lead Reduction](#). August 2010.
30. Agency for Toxic Substances & Disease Registry. [Lead Toxicity: What Are the Physiologic Effects of Lead Exposure?](#) August 25, 2016. Viewed: December 28, 2016; Janssen S, Solomon G, Schettler T. [Toxicant and Disease Database](#). Collaborative on Health and the Environment.
31. Martin S, Griswold W. (2009). Human health effects of heavy metals. *Environmental Science and Technology Briefs for Citizens* (15): 1–6.
32. Brochin R, Leone S, Phillips D, Shepard N, Zisa D, Angerio A. (2008). The cellular effect of lead poisoning and its clinical picture. *GUJHS*. 5(2): 1–8.
33. Agency for Toxic Substances and Disease Registry. [Environmental Health and Medicine Education. Lead Toxicity: What is the Biological Fate of Lead?](#) August 25, 2017
34. Dart RC, Hurlbut KM, Boyer-Hassen LV. Lead. In: Dart RC, editor. *Medical Toxicology*. 3rd ed. Lippincott Williams and Wilkins; 2004.
35. Fujita H, Nishitani C, Ogawa K. Lead, chemical porphyria, and heme as a biological mediator. *Tohoku J Exp Med*. 2002;196(2):53–64.
36. Kosnett MJ. Lead. In: Brent J, editor. *Critical Care Toxicology: Diagnosis and Management of the Critically Poisoned Patient*. Gulf Professional Publishing; 2005. ISBN 0-8151-4387-7.
37. Navas-Acien A, Guallar E, Silbergeld EK, Rothenberg SJ. Lead Exposure and Cardiovascular Disease--A Systematic Review. *Environ Health Perspect*. 2007;115:472–82.
38. Park SK, O'Neill MS, Vokonas PS, Sparrow D, Wright RO, Coull B, Nie H, Hu H, Schwartz J. Air Pollution and Heart Rate Variability: Effect Modification by Chronic Lead Exposure. *Epidemiology*. 2008;19:111–120.
39. Patrick L. Lead toxicity, a review of the literature. Part 1: Exposure, evaluation, and treatment. *Altern Med Rev*. 2006;11:2–22.
40. Zhang H, Liu Y, Zhang R, Liu R, Chen Y. Binding Mode Investigations on the Interaction of Lead (II) Acetate with Human Chorionic Gonadotropin. *J Phys Chem B*. 2014;118:9644–9650.





# EARN YOUR MBA

WWW.IIMPS.IN



Accreditation & Ranking



UGC / NCTE Approved.

INFO@IIMPS.IN

☎ 011-41005174

R  
S  
E  
A  
R  
C  
H  
G  
A  
T  
E  
W  
A  
Y

## STOP PLAGIARISM



**Arogyam Ayurveda**  
Holistic Healing through herbs



A  
R  
O  
G  
Y  
A  
M  
O  
N  
L  
I  
N  
E

## PARIVARTAN PSYCHOLOGY CENTER



### COLOR PSYCHOLOGY : HOW COLOR AFFECT YOUR CHILD



- BLUE** Calms your Child's Mind & Body
- YELLOW** Promotes Concentration, Stimulates the Memory
- PINK** Evokes Empathy, makes your Child Calm
- RED** Excites and energizes your Child's body
- GREEN** Improves Reading speed and Comprehension

www.parivartan4u.com



Confuse about your children's future?



Explore Innovate Educate

**Shri Param Hans Education & Research Foundation Trust**  
**[www.SPHERT.org](http://www.SPHERT.org)**

**भारतीय भाषा, शिक्षा, साहित्य एवं शोध**

ISSN 2321 – 9726

[WWW.BHARTIYASHODH.COM](http://WWW.BHARTIYASHODH.COM)



**INTERNATIONAL RESEARCH JOURNAL OF  
MANAGEMENT SCIENCE & TECHNOLOGY**

ISSN – 2250 – 1959 (O) 2348 – 9367 (P)

[WWW.IRJMST.COM](http://WWW.IRJMST.COM)



**INTERNATIONAL RESEARCH JOURNAL OF  
COMMERCE, ARTS AND SCIENCE**

ISSN 2319 – 9202

[WWW.CASIRJ.COM](http://WWW.CASIRJ.COM)



**INTERNATIONAL RESEARCH JOURNAL OF  
MANAGEMENT SOCIOLOGY & HUMANITIES**

ISSN 2277 – 9809 (O) 2348 - 9359 (P)

[WWW.IRJMSSH.COM](http://WWW.IRJMSSH.COM)



**INTERNATIONAL RESEARCH JOURNAL OF SCIENCE  
ENGINEERING AND TECHNOLOGY**

ISSN 2454-3195 (online)

[WWW.RJSET.COM](http://WWW.RJSET.COM)



**INTEGRATED RESEARCH JOURNAL OF  
MANAGEMENT, SCIENCE AND INNOVATION**

ISSN 2582-5445

[WWW.IRJMSSI.COM](http://WWW.IRJMSSI.COM)





# A REVIEW ON REGULATORY PROTEINS AS POTENTIAL SALIVARY BIOMARKERS IN ORAL CANCER DETECTION

*P.Rajendra Babu\* S.Ramesh \*\* R.L.Satyanarayana\*\*\*R.Swamy sabharinadh\*\*\*\**

*Senior Lecturer \* Senior Lecturer \*\* Lecturer \*\*\* Senior Lecturer \*\*\*\**

*Department of Chemistry*

*B.V.Raju College, Vishnupur , Bhimavaram, Andhrapradesh, India -534202*

**Abstract:** The Preventive measures and therapeutic strategies are attaining timely with a great efforts of clinicians and scientists of the same on oral cancer. Mere improvement in therapeutic strategies is not enough to decrease the mortality and morbidity rate of oral cancer. However the recent studies have proved that delay in diagnosis remains one of the major causes of the high morbidity and mortality rate. Therefore the aim of this review is to cover the most recent data on salivary biomarkers in the detection of oral cancer.

Salivary biomarkers serve as the diagnostic tool in oral cancer namely increased salivary fluid levels of cell cycle regulatory proteins such as Cyclin D1, Ki67, glycolytic enzymes like Lactate Dehydrogenase (LDH) and Matrix Metallo Proteinase (MMP) as diagnostic tools in oral cancer is reviewed.

**Key words:** Saliva, Oral Cancer, Cyclin D1, LDH, MMP\

## **I Introduction:**

Saliva, a biological fluid serves as the diagnostic tools as it possess several biomarkers. Bio monitoring of these biomarkers like proteins, nucleic acids, circulating tumor cells, or disease drivers related to infections proved their usefulness in the diagnosis of human diseases including oral cancer [1]. Oral cancer reported as one of the serious health problem globally [2]. The morbidity and the mortality rate of oral cancer has been increased day by day it is because of the late diagnosis in an advanced stage [3]. Screening and an early detection of oral cancer have however increases the survival rate, the reason is pre- malignant tumors even can be detected in saliva unlike that of the biopsy procedures that are available [4].



Hence, salivary biomarkers have been used widely to elucidate the clinical behavior of oral cancer [5, 6], specifically Cyclin D1, Ki-67 proteins and glycolytic enzymes (LDH and MMP) [7, 8 and 9]. To consider a molecule as a biomarker it should have to satisfy the following criteria: 1. the altered can be objectively measured; 2. must be measurable in small specimens; 3. must be altered in the high-risk tissues, but not in the normal tissues; and 4. must be altered in the early stages of cancer development [10]. This review article aims to covers the recent data on regulatory protein biomarkers with particular attention on Cyclin D1, Ki67, glycolytic enzymes like Lactate Dehydrogenase (LDH), Matrix Metallo Proteinase (MMP) role in the early detection of oral cancer.

## **II THE SALIVA AS A PERFECT DIAGNOSTIC TOOL:**

The saliva has gain an utmost importance in early detection of cancer especially in high risk patients, patients with premalignant lesions and patients with a previous history of cancer [11]. The human saliva is a clear, slightly acidic (pH= 6.0-7.0) biological and informative body fluid rich in bio molecules like protein, mRNA, and DNA that are used as biomarkers for translation and clinical applications [12]. Because of having many advantages over the serum and tissues the saliva has proved as a perfect diagnostic tool, in clinical diagnosis of pathogenic diseases. The advantages include simple collection; storing and transportation procedures, cost-effectiveness, an adequate volume of sample obtain easily, and repeated sampling for a longer period [13].

Saliva detection is essential in oral cancer among other type of cancers because of its direct contact with oral cancer lesions or tumour. The saliva of the oral cancer patient contains the altered dead cells in their oral cavity this allow us to detect the saliva for the presence of those fallen cells or altered cells commonly called as salivary biomarkers. Hence the saliva is used as the primary choice in screening and identification of salivary biomarkers in the oral cancer [14].In light of the above, the saliva has been considered as a perfect diagnostic tool in oral cancer detection.

### III SALIVARY BIOMARKERS:

The Bio markers are formed only in the tumour cells. They may be genes or gene products that are not found in the normal cells, but are highly expressed in the malignant or abnormal cells [15].

The advantages of biomarkers in oral cancer detection have summarized by Chan and Sell Table: 1 [16].

- Biomarker is a prognostic indicator in disease diagnosis.
- Tumor Volume can be estimated.
- Detection of oral cancer at early stages.
- Monitoring responses to therapy.
- Detecting the cancer recurrence.
- Direct the immunotherapy.
- Radio immune localization of tumor masses.
- Treatment success rate can be evaluated

*Table - 1 Advantage of Biomarkers:*

### IVCYCLIN D1 GENE MARKER:

Cyclin D1 is a cell cycle regulator that binds to cyclin-dependent kinase (CDK) 4 and CDK6. These cyclin-CDK complexes induce DNA synthesis and transition of cells between G1/S phases and make the cyclin D1 as a potential target in cancer detection [17, 18]. In various studies it has been reported that cyclin D1 level is increased in 30% of Head and neck SCC [19]. Indirectly the level of Cyclin D1 is increased during cancer it depends on the over expression of NF- $\kappa$ B. Consonantly, NF- $\kappa$ B levels increase gradually from pre-malignant lesions to invasive head and neck SCC via NF- $\kappa$ B signalling pathway at the early stages of carcinogenesis and activate the growth promoting genes such as c-myc and Cyclin D1 [20-23].

Moreover, an elevated Cyclin D1 expression has been associated with higher tumor size, lymph node commitment and poor prognosis [24-26].; interestingly, one of the recent study reported an increased levels of cyclin D1 was seen in invasive clones of a tongue SCC cell line when compared to its non-invasive counterpart and is correlates with the expression of Ki- 67 [27]. The studies proved that cyclin D1 is often a target in oral cancer detection [28]. A higher level of dysplasia in oral SCCs and pre-malignant lesions was also previously related to Cyclin D1 over expression [24, 29-30]. Suitably, in of the study it was reported that 80% of T3/T4 cases had significantly higher Cyclin D1 and Ki-67 expression [31]. Ki67:

Ki-67 is present throughout the cell cycle. It is a current nuclear antigen in S, G2, and M phase, helps in the outcome of a neoplastic human cell growth rate [32]. Studies proved that in cancer cells Ki 67 expressed at low to moderate levels where as Ki 67 in oral normal epithelium, expressed at low levels [33]. Several studies reported the possible association between highly expressed Ki-67 cell and normal cell [34, 35] and in a recent study it was proved that over expression of CD147 and Ki-67 is linked to a worse prognosis of tongue SCC [36].

## **V Glycolytic Enzymes:**

### **Matrix Metallo Proteinase and Lactate Dehydrogenase:**

Matrix Metallo Proteinase has been studied in various studies during cancer detection [37]. MMPs prevent apoptosis by reducing natural killer cells count it shows gelatinases and collagenases activity.

These are stromelysins, and membrane-type MMPs [38] and have the capacity to cleave FAS receptors. They plays a dual role in angiogenesis, increase the bioavailability of vascular endothelial growth factor receptor [39] active role in the cell to cell adhesion, cell to extracellular matrix adhesion, breakdown of collagen (type IV, V, VII, X), fibronectin and elastin, [40]. It regulates cell growth and inflammation by altering several protein receptors such as chemokines and cytokines [41]. In a recent study MMP-9 has applied clinically as an early detection diagnostic tool in the future [42]. The studies on MMP reported that Future studies on large populations should evaluate the possibility as an adjunct for diagnosis, during the treatment and follow-up of oral cancer.

### **Lactate Dehydrogenase:**

LDH is present in all most in every cell but it is present within the cell, the extracellular presence of LDH has been seen only in necrosis or tissues break down case. The dysplastic changes in cancer cell formation are associated with high glycolytic activity as a result breakdown of glucose to pyruvate occurs resulting in a rapid increase of lactate dehydrogenase (LDH) enzyme activity [43]. Due to high glucolytic activity the amount of lactic acid rate is increased ultimately this leads to the production of LDH because as it is consider as a key enzyme to breakdown lactic acid in glycolysis. Several studies reported the correlation between LDH with the histopathological grade of tumour [44]. The LDH level is high in tumor cell whereas the normal cell shows low rate of LDH [45, 46]. The studies on LDH all reported that it can be used as salivary biomarker for diagnosis of oral cancer.

**VI Conclusion:** Saliva has been analyzed for diagnostic purposes. Salivary biomarkers are useful in the diagnosis of variety of diseases. It is a noninvasive, uncomplicated, diagnostic tool. Oral cancer that can be monitored by assaying salivary biomarkers opens to a wider view. More studies on salivary biomarkers may prove greater insight in to various systemic diseases in human population.

### References:

1. G. Siravegna, S. Marsoni, S. Siena, and A. Bardelli, "Integrating liquid biopsies into the management of cancer," *Nature Reviews Clinical Oncology*, vol. 14, no. 9, pp. 531–548, 2017.
2. Shah, J.P., and Gil, Z. (2009). Current concepts in management of oral cancer- surgery. *Oral Oncol.* 45, 394-401. Doi: 10.1016/j.oraloncology.2008.05.017.
3. Rivera, C. (2015). Essentials of oral cancer. *Int. J. Clin. Exp. Pathol.* 8, 11884-11894. Doi: 10.1111/ane.12918.
4. C. Seethalakshmi, (2013) Early Detection of Oral Squamous Cell Carcinoma (OSCC) – Role of Genetics: A Literature Review. 2013 Aug; 7(8): 1824–1826. Published online 2013 Aug 1. doi: 10.7860/JCDR/2013/5552.3281.
5. Henriques AC, de Matos FR, Galvao HC, Freitas Rde A. Immuno histo chemical expression of MMP-9 and VEGF in squamous cell carcinoma of the tongue. *Journal of oral science.* 2012; 54:105–11. [[PubMed](#)] [[Google Scholar](#)]
6. Mohtasham N, Mahdavi - Shahri N, Salehinejad J, Ejtehadi H, Torabi-Parizi M, Ghazi N. Detection of nucleoproteins in squamous cell carcinoma, and dysplastic and normal mucosa in the oral cavity by methyl green-pyronin staining. *Journal of oral science.* 2010; 52:239–43. [[PubMed](#)] [[Google Scholar](#)]
7. Wangsa D, Ryott M, Avall- Lundqvist E, Petersson F, Elmberger G, Luo J. Ki-67 expression predicts loco regional recurrence in stage I oral tongue carcinoma. *British journal of cancer.* 2008;99:1121–8. [[PMC free article](#)] [[PubMed](#)] [[Google Scholar](#)]
8. Carlos de Vicente J, Herrero-Zapatero A, Fresno MF, López-Arranz JS. Expression of cyclin D1 and Ki-67 in squamous cell carcinoma of the oral cavity: clinicopathological and prognostic significance. *Oral Oncology.* 2002; 38:301–8. [[PubMed](#)] [[Google Scholar](#)].
9. Marsit CJ, Black CC, Posner MR, Kelsey KT. A Genotype-Phenotype Examination of Cyclin D1 on Risk and Outcome of Squamous Cell Carcinoma of the Head and Neck. *Clin Cancer Res.* 2008; 14:2371–7. [[PMC free article](#)] [[PubMed](#)] [[Google Scholar](#)]
10. Shikha Sexana et al., 2017. A Review of Salivary Biomarker: A Tool for Early Oral Cancer Diagnosis. 2017; 6: 90. Published online 2017 Jul 28. doi: 10.4103/2277-9175.211801
11. Shah FD, Begum R, Vajaria BN, Patel KR, Patel JB, Shukla SN, et al. A review on salivary genomics and proteomics biomarkers in oral cancer. *Indian J Clin Biochem.* 2011;26:326–34. [[PMC free article](#)] [[PubMed](#)] [[Google Scholar](#)].
12. Jiang J, Park NJ, Hu S, Wong DT. A universal pre-analytic solution for concurrent stabilization of salivary proteins, RNA and DNA at ambient temperature. *Arch Oral Biol.* 2009;54:268–73. [[PMC free article](#)] [[PubMed](#)] [[Google Scholar](#)]
13. Wong DT. Salivary diagnostics powzered by nanotechnologies, proteomics and genomics. *J Am Dent Assoc.* 2006;137:313–21. [[PubMed](#)] [[Google Scholar](#)]
14. Wu JY, Yi C, Chung HR, Wang DJ, Chang WC, Lee SY, et al. Potential biomarkers in saliva for oral squamous cell carcinoma. *Oral Oncol.* 2010;46:226–31. [[PubMed](#)] [[Google Scholar](#)].

15. Rassekh CH, Johnson JT, Eibling DE. Circulating markers in squamous cell carcinoma of the head and neck: A review. *Eur J Cancer B Oral Oncol.* 1994;30B:23–8. [[PubMed](#)] [[Google Scholar](#)]
16. Chan DW, Sell S. Tumor markers. In: Burtis CA, Ashwood ER, editors. *Tietz's Textbook of Clinical Chemistry.* 2nd ed. Philadelphia: WB, Saunders; 1994. pp. 897–925. [[Google Scholar](#)]
17. Chin D, Boyle GM, Theile DR, Parsons PG, Coman WB. Molecular introduction to head and neck cancer (HNSCC) carcinogenesis. *British journal of plastic surgery.* 2004;57:595–602. [[PubMed](#)] [[Google Scholar](#)]
18. Diehl JA. Cycling to cancer with cyclin D1. *Cancer Biol Ther.* 2002;1:226–31. [[PubMed](#)] [[Google Scholar](#)]
19. Namazie A, Alavi S, Olopade OI, Pauletti G, Aghamohammadi N, Aghamohammadi M. Cyclin D1 amplification and p16(MTS1/CDK4I) deletion correlate with poor prognosis in head and neck tumors. *The Laryngoscope.* 2002;112:472–81. [[PubMed](#)] [[Google Scholar](#)]
20. Mishra A, Bharti AC, Varghese P, Saluja D, Das BC. Differential expression and activation of NF-kappaB family proteins during oral carcinogenesis: Role of high risk human papillomavirus infection. *International journal of cancer Journal international du cancer.* 2006;119:2840–50. [[PubMed](#)] [[Google Scholar](#)]
21. Ondrey FG, Dong G, Sunwoo J, Chen Z, Wolf JS, Crowl-Bancroft CV. Constitutive activation of transcription factors NF-(kappa)B, AP-1, and NF-IL6 in human head and neck squamous cell carcinoma cell lines that express pro-inflammatory and pro-angiogenic cytokines. *Mol Carcinog.* 1999;26:119–29. [[PubMed](#)] [[Google Scholar](#)]
22. Reich NC, Liu L. Tracking STAT nuclear traffic. *Nature reviews Immunology.* 2006;6:602–12. [[PubMed](#)] [[Google Scholar](#)]
23. Salgueiredo-Giudice F, Correa-Abrahamo A, Fornias-Sperandio F, da-Costa-Dal-Vechio AM, dos-Santos-Pinto-Junior D. An in vitro study showing the three-dimensional microenvironment influence over the behavior of head and neck squamous cell carcinoma. *Medicina oral, patologia oral y cirugia bucal.* 2012;17:e377–82. [[PMC free article](#)] [[PubMed](#)] [[Google Scholar](#)]
24. Vieira RAMAR, Minicucci EM, Marques MEA, Marques SA. Actinic cheilitis and squamous cell carcinoma of the lip: clinical, histopathological and immunogenetic aspects. *An Bras Dermatol.* 2012;87:105–14. [[PubMed](#)] [[Google Scholar](#)]
25. Fujii M, Ishiguro R, Yamashita T, Tashiro M. Cyclin D1 amplification correlates with early recurrence of squamous cell carcinoma of the tongue. *Cancer Lett.* 2001;172:187–92. [[PubMed](#)] [[Google Scholar](#)]
26. Wang L, Liu T, Nishioka M, Aguirre RL, Win SS, Okada N. Activation of ERK1/2 and cyclin D1 expression in oral tongue squamous cell carcinomas: relationship between clinic pathological appearances and cell proliferation. *Oral oncology.* 2006;42:625–31. [[PubMed](#)] [[Google Scholar](#)].
27. Giudice FS, Dal Vechio AM, Abrahamo AC, Sperandio FF, Pinto-Junior Ddos S. Different expression patterns of pAkt, NF-kappaB and cyclin D1 proteins during the invasion process of head and neck squamous cell carcinoma: an in vitro approach. *Journal of oral pathology & medicine: official publication of the International Association of Oral Pathologists and the American Academy of Oral Pathology.* 2011;40:405–11. [[PubMed](#)] [[Google Scholar](#)]
28. Abrahamo AC, Giudice FS, Sperandio FF, Pinto Junior Ddos S. Effects of celecoxib treatment over the AKT pathway in head and neck squamous cell carcinoma. *Journal of oral pathology & medicine : official publication of the International Association of Oral Pathologists and the American Academy of Oral Pathology.* 2013;42:793–8. [[PubMed](#)] [[Google Scholar](#)]



29. Kovesi G, Szende B. Prognostic value of cyclin D1, p27, and p63 in oral leukoplakia. *Journal of oral pathology & medicine : official publication of the International Association of Oral Pathologists and the American Academy of Oral Pathology*. 2006;35:274–7. [[PubMed](#)] [[Google Scholar](#)]
30. Turatti E, da Costa Neves A, de Magalhaes MH, de Sousa SO. Assessment of c- Jun, c- Fos and cyclin D1 in premalignant and malignant oral lesions. *Journal of oral science*. 2005;47:71–6. [[PubMed](#)] [[Google Scholar](#)]
31. Eduardo – Pereira Guimaraes et al., (2015). Cyclin D1 and Ki-67 expression correlates to tumor staging in tongue squamous cell carcinoma. 2015 Nov; 20(6): e657–e663. Published online 2015 Oct 9. doi: 10.4317/medoral.20601.
32. Gerdes J, Lemke H, Baisch H, Wacker HH, Schwab U, Stein H. Cell cycle analysis of a cell proliferation-associated human nuclear antigen defined by the monoclonal antibody Ki-67. *Journal of immunology*. 1984;133:1710–5. [[PubMed](#)] [[Google Scholar](#)]
33. Faratzis G, Tsiambas E, Rapidis AD, Machaira A, Xiromeritis K, Patsouris E. VEGF and ki 67 expression in squamous cell carcinoma of the tongue: An immunohistochemical and computerized image analysis study. *Oral oncology*. 2009;45:584–8. [[PubMed](#)] [[Google Scholar](#)]
34. Thomson PJ, Hamadah O, Goodson ML, Cragg N, Booth C. Predicting recurrence after oral precancer treatment: use of cell cycle analysis. *The British journal of oral & maxilla facial surgery*. 2008; 46:370–5. [[PubMed](#)] [[Google Scholar](#)]
35. Kumar P, Kane S, Rathod GP. Coexpression of p53 and Ki 67 and lack of c-erbB2 expression in oral leukoplakias in India. *Brazilian oral research*. 2012;26:228–34. [[PubMed](#)] [[Google Scholar](#)]
36. Yu YH, Morales J, Feng L, Lee JJ, El-Naggar AK, Vigneswaran N. CD147 and Ki-67 overexpression confers poor prognosis in squamous cell carcinoma of oral tongue: a tissue microarray study. *Oral Surg Oral Med Oral Pathol Oral Radiol*. 2015;119:553–65. [[PMC free article](#)] [[PubMed](#)] [[Google Scholar](#)].
37. Wu J-Y, Yi C, Chung H-R, et al. Potential biomarkers in saliva for oral squamous cell carcinoma. *Oral Oncol*. 2010;46:226–31.
38. Hema Shree K, Ramani P, Sherlin H, et al. Saliva as a diagnostic tool in oral squamous cell carcinoma – a systematic review with meta analysis. *Pathol Oncol Res*. 2019;25:447– 53. [[PubMed](#)] [[Google Scholar](#)].
39. Venugopal A, Uma Maheswari T. Expression of matrix metalloproteinase-9 in oral potentially malignant disorders: A systematic review. *J Oral Maxillofac Surg Med Pathol*. 2016;20:474–9. [[PMC free article](#)] [[PubMed](#)] [[Google Scholar](#)]
40. Chen Y, Zhang W, Geng N, Tian K, Jack Windsor L. MMPs, TIMP-2, and TGF-β1 in the cancerization of oral lichen planus. *Head Neck*. 2008;30:1237–45. [[PubMed](#)] [[Google Scholar](#)]
41. Henriques ACG, de Matos FR, Galvão HC, Freitas R de A. Immunohistochemical expression of MMP-9 and VEGF in squamous cell carcinoma of the tongue. *J Oral Sci*. 2012;54:105–11. [[PubMed](#)] [[Google Scholar](#)].
42. Komal Smriti et al., (2020). Salivary MMP-9 as a Biomarker for the Diagnosis of Oral Potentially Malignant Disorders and Oral Squamous Cell Carcinoma. 2020; 21(1): 233–238. doi: [10.31557/APJCP.2020.21.1.233](https://doi.org/10.31557/APJCP.2020.21.1.233).

43. Epstein JB. Oral cancer. In: Greenberg M, Glick M. ed. Oral Medicine, Diagnosis and Treatment, 10th ed. India: Elsevier; 2003. pp. 194–234.
44. Tejashree Mantr et al., (2019). Study of the Role of Salivary Lactate Dehydrogenase in Habitual Tobacco Chewers, Oral Submucous Fibrosis and Oral Cancer as a Biomarker. The Journal of Contemporary Dental Practice, Volume 20 Issue 8 (August 2019). Pp. 970-973.
45. Lokesh K, Kannabiran J, Rao MD. Salivary Lactate Dehydrogenase (LDH)-A Novel Technique in Oral Cancer Detection and Diagnosis. Journal of clinical and diagnostic research: JCDR. 2016;10(2):ZC34
46. Shpitzer T, Bahar G, Feinmesser R, Nagler RM. A comprehensive salivary analysis for oral cancer diagnosis. Journal of cancer research and clinical oncology. 2007;133(9):613–7. [[PubMed](#)] [[Google Scholar](#)].





## Robert Gagne's Nine Instructional Model of Session Plan to Bloom's Taxonomy Levels of Questions with Innovative Digital Platforms

Dr. D. Vijaya Lakshmi, Associate Professor, Vishnu Institute of Technology,  
Bhimavaram

K. Krishna, Lecturer, Padmasri Dr. BV Raju Institute of Computer Education,  
Bhimavaram

N. Krishna Mohan Raju, Associate Professor, Vishnu Institute of Technology,  
Bhimavaram

[vijayalakshmi.d@vishnu.edu.in](mailto:vijayalakshmi.d@vishnu.edu.in)  
9490133459

---

---

### Introduction

English is not just a language. It is a language of empowerment through teaching and learning and of enrichment and entertainment. Innovation is the driving force of progress. Today, the digital revolution is playing a vital role in taking English language teaching forward and has become core to language teaching. Globally, English is the medium of instruction in higher education. Teachers can make active use of tools and technologies to improve standards of the students. Approaches and techniques in teaching may differ according to the student's skills. This paper aims to make acquainted the techniques and methods of English language teaching in exploring the new ways for teaching learning approach. As a part of techniques and methods, the development of this paper focuses on Robert Gagne's Nine Instructional Model of session plan to Blooms Taxonomy levels of question paper with innovative digital platforms like Google Classroom, Mind mapping etc. If English language is taught through innovative technologies the entire ambience of the classroom will be pleasant, enjoyable, satisfying and amusing.

There are many ways to plan a session. Among all of them the highlighted session plan is Robert Gagne's Nine Instructional Model with teacher details. For instance:

Faculty & Subject Details		Class Details	
Name of the Faculty		Academic Year	
Designation		Semester	
Department		Branch	
Subject Name		Class / Section Name	
Session Topic		Date	

A session plan is classified into three phases such as the beginning, the body, and the closing.

**i. The Beginning**

Sharing the Topic Learning Objectives (TLOs) with Bloom’s Taxonomy classification:

*After the completion of the portion of the lecture, the learner should be able to:*

1. To make them **remember** the important points of the lesson.
2. To show their **understanding** regarding the theme that has been covered throughout the lesson.
3. To **apply** the concept which is discussed in the lesson in the real life situation.
4. To **analyse** the comparisons and contrast of the given information.
5. To **evaluate** the given data by providing examples from media such as T.V. newspaper, etc.
6. To plan (**create**) for an essay question.

**Pre-class Preparation**

The Greatest Resource – Education is the name of the first lesson. Students are motivated to understand from the author’s point of view. The highlights of the lesson are about various civilizations and about the development of human mind. Pace set up plays a key role before the class starts. Designing of the activity is also very vital before handling the class. Brainstorming and Mind mapping are the planned activities for this lesson plan. These activities may vary based on the lesson.

**ii. The Body**

If these are all revealed the learner will know not only what the content will be, but also the level of mastery. Usually, any teacher follows knowingly or unknowingly Robert Gagne’s Nine Instructional Model. The focus will be on gaining attention, Informing objective, stimulating recall of prior knowledge, presenting information, providing feedback, providing guidance, eliciting performance, assessing performance, and enhancing retention. Emphasizing the outcome of the session is also a necessary factor. It is shown in the tabular form to the extent of time limit of 50 minutes.

<b>Event</b>	<b>Session Plan on The Greatest Resource - Education</b>	<b>50 min. hr.</b>
Gaining Attention	Importance of Education through posing questions and eliciting answers	5 mins
Informing objective	Reading Skills Development based on the given content	2 mins
Stimulating recall of	Brainstorming	5 mins

prior knowledge		
Presenting information	Skimming & Scanning (Methods of Reading) Comprehension Questions are asked to get the theme - PPT	15 mins
Providing feedback	If any wrong interpretation is given it will be clarified and others' doubts are discussed	5 mins
Providing guidance	By giving the inputs from the newspaper articles	3 mins
Eliciting performance	Presentation of the content by a few	5 mins
Assessing performance	Mind Mapping	12 mins
Enhancing retention	Consolidation, recap and briefing of next topic	3 mins
Outcome	Knowledge Acquisition, Communication Skills, Clarity of Thought and Speech	

### iii. The Closing

Misconceptions identified to address in the class include stimulate the students to clarify their doubts regarding concepts, language etc, provide example to make them come out of their confusion and mostly guided the students to undo their own misconceptions. Different kinds of questions are designed to discuss in the class. They are language based questions, factual based questions, opinion based questions, inference based questions and content based questions. Learning Styles covered by various in-class activities are: Spatial or Visual (Pictures and video were shown), Logical (Questions are asked to elicit answers), Interpersonal (at time of brainstorming activity) and Intrapersonal (managed himself/herself in giving answers). The results of the student are the proof for this success story of Robert Gagne's Nine Instructional Model.

Assessment Process is based on Bloom's Taxonomy Levels (Remember, Understand, Applying, Analysing, Evaluating and Creating) in all educational institutions in these days to test performance of the learners. It is an index to verify the levels are being assessed and correspond the assessment tools with the relevant lessons and techniques. Thereby it may help teacher to retain uniformity in assessment practices, education material and reveal weaknesses.

### I. Innovative Digital Platforms

Technological tools used in the instruction delivery to the learners are Google Classroom, Mind Mapping, and YouTube. These tools are helpful for blended learning. They can work on them and submit through online after completion of the class work.

#### i. Google Classroom

It gives an exposure to online learning. It stores important classroom material that students will refer to throughout the semester. For example, syllabus, rules and regulations, helpful links for lessons etc. It allows communicating better with students outside the classroom. Automatic due dates of the assignments are provided to the students. Then they can submit their assignments from anywhere. They need not work in the classroom physically. Google Classroom saves time and paper and it allows everyone to join class with a code. Students may submit assignments and can get real time feedback and grades. It is the right platform for creating material, assignments, announcements etc. At the outset, one can say that Google Classroom is one of the fantastic innovative educational tools. Whatever may be the subject is, it is a great tool for sharing information with the students. No more collecting homework, reviewing and grading. All will be possible and very easier with Google Classroom. Since it can be accessed from mobile device, teachers and students can use their phones. It offers numerous ways to make teaching and learning interactive and collaborative. Work in the Google Classroom is easily saved to the drive. No problem of removing and crashing the content. As a free online software Google Classroom gives several benefits to the teachers and students.



## ii. Mind mapping

Mind mapping is a highly effective way of getting information in and out of the brain. Mind mapping converts a long list of monotonous information into a colourful, memorable, and highly organized diagram. Moving from paper to apps has been an easy transition. Freemind, mindomo, and mindmap are a few apps suggested to students to draw mind maps. It gives infotainment. These mind map tools help edit and create mind maps quickly. To make the map clearer students usually apply styles, add icons and use shapes and colours. If the students use in the right way, it improves independent learning and critical thinking. This tool is an absolute time saving strategy during the time of examinations.

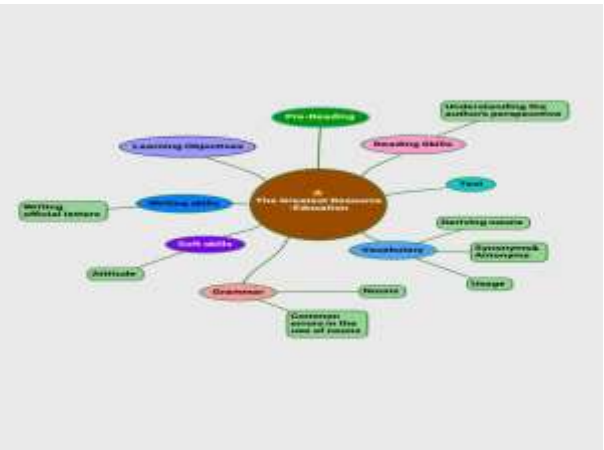
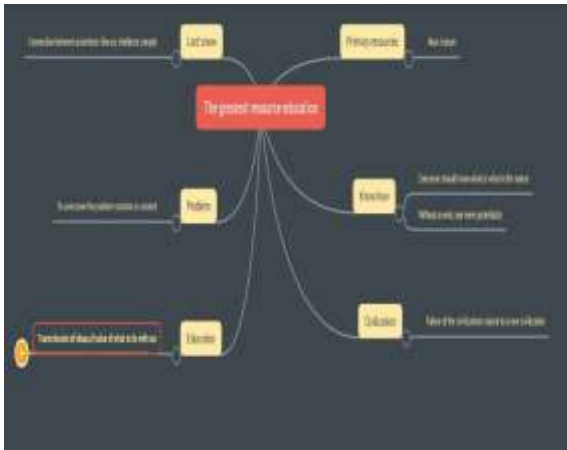

iii. **YouTube**

There are books and classroom lessons but having a variety of material can promote learning. As it is a known fact that some students are visual learners, and some are auditory learners. After completion of explanation in the classroom YouTube videos will be posted to the students. Whenever they want to refresh the content of the lesson can listen to the videos. They can pause and rewind videos whenever they need. It may be comfortable. and they may habituate to listen to the same voice of the same teacher in the class. It is one of the interesting methods to enhance the level of the students’ knowledge.

Students will never study regularly for writing Semester examinations is a known fact. They study vigorously and rigorously before the day of examination. By understanding the mindset of the students, a YouTube channel was started. The analytics of the YouTube is given below. In the month of December Mid II took place, the way they studied was shown in the graph. The difference between preparation for Mids and Sem end exams is noted through this graph. If the analysis is observed by the teacher students will be catch hold at least two weeks before the examination.



The improvement of views and topmost videos are observed in the form of graph and various activities. How much the students focus on the technology is known through this clustered image. These students are born in technology, so they are called digital natives. Thinking from the point of view of them or from the shoes of the student is quite necessary in these days. Act and plan according to their needs and interests is the need of the hour of a facilitator. Revolutionary changes in the society and technology exhort every teacher to update their methodologies and techniques according to the requirements of the students.

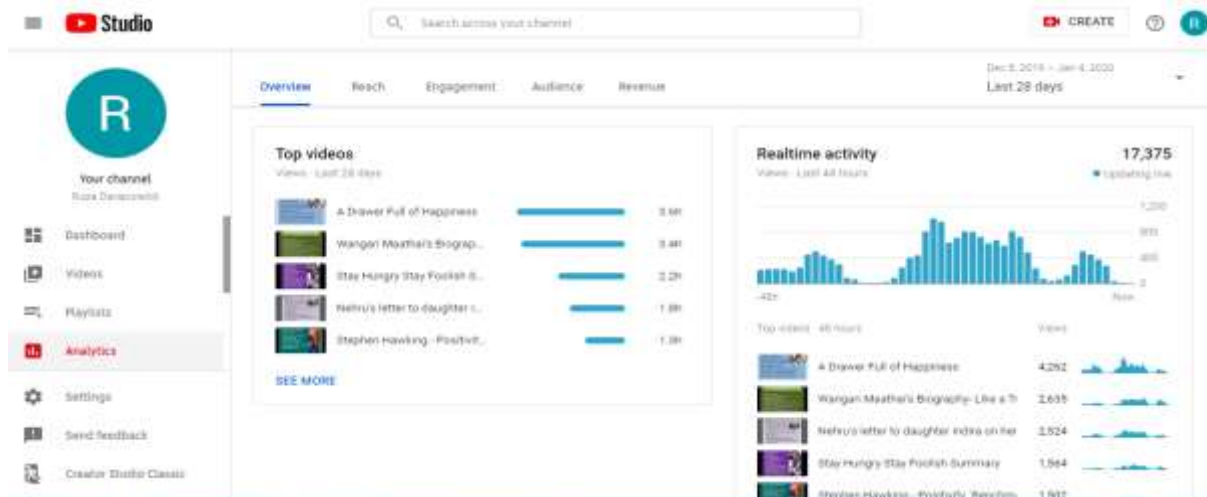

## II. Bloom's Taxonomy Questionnaire

Creating awareness to engineering students on Bloom's Taxonomy is compulsory as they should know about each level while they are answering the questions. It is the instructor's responsibility to make them practice it in the classroom. After completion of each lesson in the class, students are asked to plan a questionnaire based on all the levels such as remember, understand, apply, analyze, evaluate and create. While they are planning to frame the questions list of verbs (describe, define, compare, contrast, divide, distinguish, evaluate, justify, consider, write etc) will be provided for better framing of questions. Once a student is exposed to frame the questions by using the data they can answer perfectly in the examination. What level of question is asked in the examination will be clearer to the learner if they practice in the classroom. Triggering the questions for writing answers in the examinations will be simpler and easier.





### III. Conclusion

The higher education landscape is undergoing rapid change due to implementation of innovative techniques in the language classrooms. Since last decade, various techniques have been used to assist and to enhance language learning. Nowadays classrooms and language labs are transformed by the integration of new techniques and trained teachers. The effectiveness of the techniques depends on the knowledge and expertise of the language teacher who facilitates the language learning environment. This research paper is limited to a few online tools but there is a wide scope for working on various digital platforms, and also preparing session plans by various researchers will be an added advantage to include in this paper. A vast area of research is taking place on Blooms Taxonomy Questionnaire at present. So, this research paper paves the way for numerous researchers on various ideas.

---

### References

Anderson, L. W., Krathwohl, D. R., Bloom, B. S. (2001). A taxonomy for learning, teaching, and assessing: A revision of Bloom's taxonomy of educational objectives. [Online]. Available at: <http://cmapspublic2.ihmc.us/rid=1Q2PTM7HL-26LTFBX-9YN8/Krathwohl%202002.pdf> [Accessed 20 March 2018].

Biggs, J. (1996). Enhancing teaching through constructive alignment. Higher Education. [Online], Vol. 32 No. 3, pp. 347-364. Available at: <https://link.springer.com/article/10.1007/BF00138871> [Accessed 15 March 2018].

Biggs, J. (1999). Teaching for Quality Learning at University. Society for Research in Higher Education and Open University Press, Buckingham. [Online]. Available at: <https://03hoezb55jq12.storage.googleapis.com/EgakKnjEN8nakamTWT12.pdf> [Accessed 15 March 2018]



Lakshmi, V. D. (2021). Innovative Online Assessment Tools in Online Education. Proceeding of the National Level Virtual Conference on E-Education, E-Learning, E-Management and E-Business (NC4E), 2020, pp.10-15.

Lakshmi, V. D. (2014). Teaching Writing Skills for Engineering Students. International Journal of Engineering Sciences and Technology. Vol 3.4., pp 1875-1878.

=====



# A REVIEW ON MATHEMATICAL MODELING OF THE GLUCOSE–INSULIN SYSTEM

Authors: Ch. Satyanarayana\*, P.Madhura Subhashini\*\*, D.S.Priyadarsini\*\*\* M.Siva \*\*\*\* Department of Mathematics, B.V.Raju College, Vishnupur, Bhimavaram , West Godavari District, Andhra Pradesh

534202

**Abstract:** The only possibility to investigate the metabolic disease dynamics is by Mathematical models. The present review was performed in order to determine to what extent different mathematical models have been incorporated in understanding the homeostatic controls, for analyzing experimental data, for identifying as well as for evaluating diabetes disease progression. A silent epidemic Diabetes sweeping the world contributing the growing burden of human activities' reducing levels as well as growing incidence of obese. In the earlier studies various models were proposed and investigated to interpret about aldohexose and hypoglycemic agent and rate of diabetes prevalence among the population with series health impacts. Several reviews have been studied about the significance of mathematical models in various aspects of disease progression. The variables required for the mathematical model includes the glycogen's concentration in the tissues/liver, glucose, hormone glucagon, and insulin in the venous blood plasma.

**Keywords:** Mathematical model, diabetes, glucose-insulin dynamics, disease progression.

## Introduction:

The study of science is ubiquitous that deals with the spatial arrangement, quantity and it is the indivisible units of life for everything in our daily lives, including various appliance, ancient and modern designing and constructing buildings, art, economy, engineering, and even competitive physical activity. Biomathematics is a fast-growing with exciting modern applications such as differential equations one among them which has basic importance in mathematics due to many biological laws and relations. To study the molecular process of the cell species related to time of natural selection, ordinary differential equations methods are used to formulate. The process of diffusion in the cell is high enough to describe these equations particularly about the arrangement of a phenomenon across homogenous molecules. To

study the relationship between the variables in large system, the most commonly as well as dependable mathematical technique is differential equation. Furthermore, molecular dynamics is generally utilized for modelling the biomolecules, at the molecular scale, moving as a Newtonian particles' system with interaction described through a force field, including several methods working for handling the solvent effects' challenges.

Predictions and analysis in life sciences' several areas, for instance expanding population in a systematic pattern, immunology, physiological processes, and neural networks are more reliable within the field of mathematics by modeling methods (R. Rakkiyappan, G. Velmurugan et al., (2015); S. Lakshmanan, et al., (2014); F. A. Rihan, (2014); F. A. Rihan and G. A. Bocharov, 2000). The time between cell's infection as well as also new visions' invention, the infectious period's duration, to initiate resistance, as well as so on can be studied by time lag models (F. A. Rihan, 2014). At the identical time instant, the unknown states as well as their derivatives are calculated in "Ordinary Differential Equations (ODEs)" but in "Delay Differential Equation (DDE)", although, at a specific time instant, the system's evolution is based on the earlier memory/history ends up in incorporate the delays of time during a differential model raises the complexities significantly. Hence, studying such models' qualitative behaviors, utilizing bifurcation or stability analysis, is critical (M. Gozen and C. Tunc, 2017). It involves providing solutions to mathematical problem as well as interpretation of such solutions within the real world language, conclusion validation through their comparison with the things, so either model is improved or, in case this is acceptable, and model is applied to related conditions for calculation and refinement. The flowchart for the method of mathematical model is given below: Bukova-Guzel, 2011).

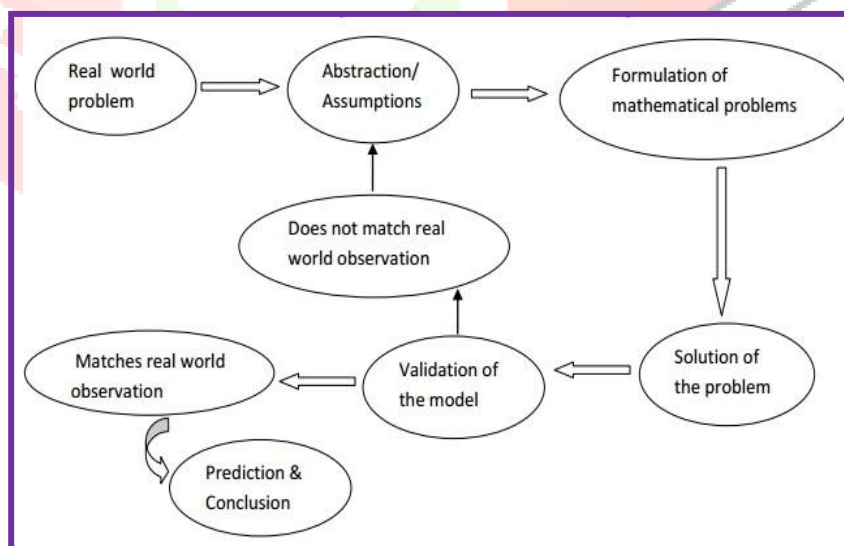

**Figure 1- Flow chart for the process of mathematical modeling**

Mathematical modeling is also classified in keeping with the mathematical techniques employed in solving them, the aim we've got for the model and per to their nature: linear or non-linear, stationary or energetic, random probability or deterministic, discrete or continuous. Essentially most realistic models are non-linear, dynamic and stochastic although linear, static or deterministic models are easier to handle

and also give good approximate results.

Types of mathematical models (Kanpur, 1988) are listed below:

- (i) Realism of models,
- (ii) Hierarchy of models,
- (iii) Relative precision of models
- (iv) Robustness of models
- (v) Self-consistency of models
- (vi) Complexity of models

Many researchers (Dubey et al., 2011; Boutayeb and Kerfati, 1994; Brandeau, 2005; Eddy and Schlessinger, 2003; Freedman and Shukla, 1991) have utilized these models for understanding as well as predicting the Biological Systems' behavior.

### **Real life use of Differential Equations**

The world around us was able to be predicted by the remarkable character of differential equations in wide selection of disciplines, from biological sciences, physical, chemical and social sciences and technology. These equations can describe the exponential growth phase and decline and introduce growth of species or changes reciprocally over time for investment a number of these variables may be solved (to get  $y = \dots$ ) and can be represented in the form  $dp/dt = \dots$  simply by integrating the differential equation but, others require much more complex process.

### **Population Models:**

Differential equations can explain exponential population ( $p$ ) and arithmetic food supply changes with respect to time growth  $dp/dt = rp$ . There will be some changes in constant  $r$  which depends on the species to be predicted that over time how that species will grow. Models can be deduced to explain the relation among prey and predators as variables of differential equations. For instance, with increase in predators there is decrease in prey which resulted in predators getting lesser to eat, thus, they started dying out, due to that resulted in survival of more prey, and such interaction among 2 populations are associated through differential equation.

### **Glucose metabolism:**

The human body comprises of several organs. Every organ has a particular function as well as they significantly plays their responsibilities so that significant biological activities are maintained in human body. For carrying through their functions, every organ requires an adequate as well as stable supply of glucose from the blood. As hyperglycemia induces glucotoxicity It is significant keeping the optimal

levels of blood glucose (Kaiser N, Neshar R, Leibowitz G, 2003) whereas organs' normal functioning is suppressed by the hypoglycemia. For such reason, under normal metabolic conditions, the human body is designed for maintaining the blood glucose levels in the 80 and 120mg/dL range.

The most abundant aldohexose in nature is glucose, its main energy source is cells of the human body. Diabetes is a disease of long-term complications evident across all sections of society in India with more than 72.9 million adults living (IDF, 2017). It is a condition when blood glucose level exceeds the normal range i.e., 75 -110 mg/dl for a long period of time. 4 million people died in 2017, due to diabetes and approximately 425 million adults in the world had diabetes. Prevalence rate by the year 2045 the diabetes people number will be increased to 629millions. In 2017, 21 million new born babies are affected by diabetes and approximately more than 1,106,500 children have type -1 diabetes and due to the increasing sedentary life habits nearly 352 million people may have the risks of type-2 diabetes development (International Diabetes Federation, 2017). India was ranked up from 11th (2005) to 7th (2016) due to number of deaths by diabetes (Hindustan times2017).

Furthermore, reproductive state, exercise, digestion rate, food intake etc. are affected by the blood glucose concentration levels. Also, the glucose concentration levels are controlled by the glucagon and insulin, pancreatic endocrine hormones. Insulin and glucagon are secreted by the pancreas's  $\beta$ -cells as well as  $\alpha$ -cells. In high concentration of blood glucose, insulin is released by the  $\beta$ -cells that resulted in decreasing the concentration levels of blood glucose by making excess glucose to be utilized by the various cells (e.g., muscles). Hernandez, 2001 stated that glucagon is released by  $\alpha$ -cells, in low concentration of blood glucose, which resulted in higher blood glucose levels through their action on liver cells into the blood.

Several models were recommended and reviewed in the field of diabetes to discuss diabetes' various aspects like diabetes prevalence as well as its symptoms; insulin as well as glucose availability; affordances to the cost of diabetes treatment, In the majority of reviews are focused on particular aspects of Sundell (2003), Mari (2002), Bergman, (2001), (1997); Nucci G, Cobelli (2000) mathematical and software aspects Kuang Y, Li J, Makroglou A (2006), glycemic index; Andersons, De Grandpre E, Kalergis M (2005); burden and cost of diabetes Boutayeb A (2006), Atun R, Gurol-Urganci I (2005). One review cannot express all the variables of various model published on diabetes models' various aspects. The present review paper is worth trying over viewing the mathematical model validation on glucose insulin dynamics. Hyperglycemia or hypoglycemia is a condition when concentration levels of glucose are beyond the normal range 70–110mg/dl, then the individual is believed to suffer from issues related to blood glucose. Furthermore, Diabetes mellitus is the glucose-insulin regulatory system's disease (Bergman, Finegood, Kahn 2001) that is known as hyperglycemia, for the interaction loops of glucose-insulin. Disease includes changes in retina, kidney diseases, diabetic nerve pain and other complications

suffering various diabetic patients as well as regarding the affected population's size, among the world's worst diseases one is diabetes mellitus WHO, (2017).

It encourages to review present paper to study the glucose-insulin endocrine regulatory system by minimal model. Many mathematical models were developed by many researches to study the regulatory pathway of insulin in utilizing glucose. The "minimal model" is the most noticeable model that comprises minimal parameters (Bergman, C. Cobelli 1980) such as for estimating "Insulin Sensitivity (SI)" and "Glucose Effectiveness (SG)" from "IVGTT (Intravenous Glucose Tolerance Test)" data through sampling over definite times, which focuses on glucose synthesis and breakdown and utilization in a short time period at time  $t = 0$ , starting from the intake of food. Other mathematical models like ordinary differential equation addressing the insulin secretion are based on controls by exercise and meals according to Mari(2002).

Differential equations that describe dynamically changing phenomena, evolution, and variations in the daily usage and in scientific fields as weather modeling, designing the reaction rates, genetic variations and even in market price analysis etc.

**The minimal model:** Fig. 2A represents the minimal model's diagrammatical representation; Fig. 2B explains the underlying minimal assumptions of insulin and glucose kinetics after injection. The following are included in the required processes:

- 1) Overnight fasting condition, leads to production of endogenous renal (and hepatic) glucose through basal glucose utilized by brain (total's 50%) as well as other tissue.
- 2) Post-Prandial Blood sugar explains the measures of glucose after two hours of eating any meal it means the ability of glucose for enhancing its own disposal as well as suppresses production of liver, which is independent activity of the plasma insulin response (Ader, (1997); Bergman(1979),
- 3) Carbohydrate intake causes a rapid response of insulin significant for renormalization of glucose leads to affect insulin levels on glucose uptake and production is not manifested immediately, however, in insulin's actions a considerable temporal delay is required by modeling.

How is the minimal model being useful? Various independent laboratories validated the model w Korytkowsk (1995) and, associated with experiment work, which helps to improve the physiology and pathophysiological conditions understanding paves to study the tools useful in the clinical and in epidemiological and genetic studies (Flanagan,2007).



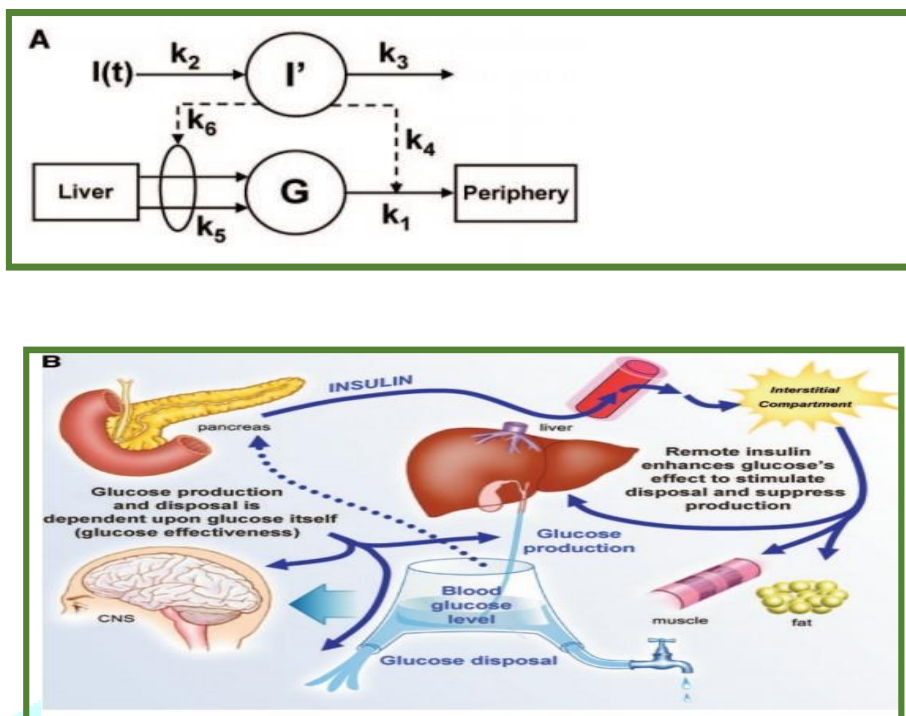

Fig2: Glucose Kinetics' Minimal model. 2A) Insulin in plasma [I(t)] crosses the endothelial barrier for entering interstitial fluid (I). Glucose Production (G) through liver as well as glucose disposal in periphery is remote controlled, (i.e., Interstitial) insulin concentration adapted from Chernick, et al., 1987. 2B) Minimal model's diagrammatic representation. Liver production and insulin dependent (Skeletal muscle) and insulin independent (brain) mechanisms are used to determine the fasting blood glucose level adapted from Bergman (1979).

Glucose-insulin dynamics' mathematical models: Numerous models were recommended to study the glucose-insulin energetics, including various Tolerance Tests. Bolie 1961 proposed Mathematical models were utilized for estimating the insulin-glucose and glucose disappearance dynamics in general, utilizing normal differential equation, as the following simple model:

$$\frac{dG}{dt} = -a_1G - a_2I + p, (1)$$

$$\frac{dI}{dt} = -a_3G - a_4I (2)$$

G = G (t) represent the concentration of glucose, I = I (t) represent the insulin as well as p, a<sub>1</sub>, a<sub>2</sub>, a<sub>3</sub>, a<sub>4</sub>are parameters respectively.

Parameter defines the characteristics of modeled objects as an amount of a quantity that impacts the output or behavior of a mathematical object which can be a number or function that holds as constant. Variables and Parameters are related to each other Variables are expressed and changeable but parameters typically won't change or change more slowly. For instance while executing many experiments variables are found to be differentiating in each experiment but the parameters are fixed during each experiment and only



change between experiments. Parameters appear within function. For example, if  $f(x)=ax^2+bx+c$ , Where, the variable  $x$  is the input to the function.  $a$ ,  $b$ , and  $c$  represents the parameters that determine the function behavior.

According to ordinary differential equation modeling started by naming as Minimal model which motivated to generate the modeling path of glucose-insulin dynamics. Bergman (2002) proposed based the pioneering works of Bolie (1961) and Derouich and Boutayeb (2002).

The form of the IVGTT *minimal model* was formulated as:

$$\frac{dG(t)}{dt} = -[p_1 + X(t)]G(t) + p_1G_b, G(0) = p_0 \quad (3)$$

$$\frac{dX(t)}{dt} = -p_2X(t) + p_3(I(t) - I_b), X(0) = 0 \quad (4)$$

$$\frac{dI(t)}{dt} = p_4(G(t) - p_5)^+ - p_6(I(t) - I_b), I(0) = 0 \quad (5)$$

Where  $(G(t) - P_5)^+ = G(t) - P_5$ , if  $G(t) > P_5$ , 0, if  $G(t) \leq P_5$ ,  $P_0, P_1, P_2, P_3, P_4, P_5, P_6, P_7$  are parameters Representing as  $I_b$  [IUI/ml] represents baseline insulinemia of subject;  $G_b$  [mg/dl] represents the baseline glycemia of subject;  $X(t)$  [min<sup>-1</sup>] represents an artificial non-observable variable which represents insulin-excitabile tissue glucose uptake activities;  $I(t)$  [IUI/ml] represents concentration of blood insulin;  $G(t)$  (mg/dl) represent glucose concentration blood at time  $t$  minutes; The minimal model in a modified version where parameters related to physical exercise were introduced as an example proposed by Derouich and Boutayeb results as

$$\frac{dG(t)}{dt} = -(1 + q_2)X(t)G(t) + (p_1 + q_1)(G_b - G(t)), \quad (6)$$

$$\frac{dX(t)}{dt} = -p_2X(t) + (p_3 + q_3)(I(t) - I_b) \quad (7)$$

$q_1, q_2, q_3$  represents physical activity related parameters as well as represents as

$q_1$ : the glucose utilization through the liver insulin and muscles based the physical exercise's effect,

$q_2$ : effect of insulin with increasing the liver sensibility and physical activity of muscles,

$q_3$ : increasing the insulin utilization the physical exercise effect. Also, insulin effectiveness is increased

by  $q_3$  for improving glucose disposal as well as thus enhancing insulin sensitivity for becoming:

$$SI = (p_3 + q_3) (1 + p_2)/P_2.$$

As stated by Makroglou, et al., (2006) and some other researchers discussed that the minimal method has minimum number of constants and also had drawbacks such as:

- 1) Measurable factors fitting the model to be performed in 2 steps: 1<sup>st</sup> as input data the insulin concentration is used, then by glucose as input data for parameter derivation in the 3<sup>rd</sup> equation.
- 2) This model produced results are not realistic (positive equilibrium problem as well as solution are not bounded).
- 3) To study the delay in insulin action, an artificial non-observable variable  $X(t)$  is presented.

Considering the above said remarks De Gaetano and Arino (2000) stated dynamical model, which is an aggregated delay differential model, due to the glucose-insulin system was an integrated physiological dynamic system.

**Dynamic model:** In the dynamic model the parameters were renamed as a result the equation:

$$\frac{dG(t)}{dt} = -b_1G(t) - b_4I(t)G(t) + b_7, G(0) = G_b + b_0 \quad (8)$$

$$\frac{dI(t)}{dt} = -b_2I(t) + \frac{b_6}{b_5} \int_{t-b_5}^t G(s)ds, I(0) = I_b + b_3b_0 \quad (9)$$

With  $G(t) = G_b$  for  $-b_5 \leq t < 0$ .

The dynamic model recalled by Mukhopadhyay et al. (2004) stated that both glucose uptake and insulin secretion parameters simultaneous estimation is allowed by this model, and recommended an extension for the pancreatic response to glucose through organ weight function,  $w$ , which is introduced in the integral kernel's delay.

Thus, obtained new model is as below:

$$\frac{dG(t)}{dt} = -b_1G(t) - b_4I(t)G(t) + b_7, G(0) = G_b + b_0 \quad (10)$$

$$\frac{dI(t)}{dt} = -b_2I(t) + b_6 \int_0^\infty \omega(s)G(t-s)ds, I(0) = I_b + b_3b_0 \quad (11)$$

With  $G(t) = G_b$  for  $t < 0$ .

As minimal model problems are solved by the dynamical model, few assumptions are made explicitly or implicitly which are not realistic. Dynamical model was replaced by Li et al. (2001) proposed general model. For instance, it has been assumed by the word  $b4I(t)G(t)$  that here mass action law is applied, whereas, a realistic, general and popular substitute is replacing the particular word with  $b4I(t)G(t)/(\alpha G(t) + 1)$ . In this model delay was restrictive with  $G(t) = G_b$  for  $-b5 \leq t < 0$  as well as  $Gt(\theta) = G(t + \theta)$ ,  $t > 0$ ,  $-b5 \leq \theta < 0$ .

**Minimal Model Applications:** Widely applied to physiological and pathophysiologic conditions, in subjects. Literature revealed that nearly 900 minimal model were performed in various subjects where mathematical treatments are implied (Godsland et al, (2006); Zheng Y, Zhao M (2005) among animals (Pacini et al., 2001) and humans (Flanagan et al., 2007). Various applications have employed based on the sampling for example IGTT resulting insulin secretory and sensitivity response. The minimal model utilization is still continuing still and successfully helpful to perform metabolic profile which may be utilized for population genetics, population dynamics, therapeutic regimens' comparison, and pathophysiologic and physiologic studies.

**Discussion and Conclusions:** Mathematical models are interesting tools to provide future predictions and for diseases progression understanding by providing visions, improving perceptions, for formal theory clarifying assumptions, allowing for study planning, parameters estimation, sensitivities determination. Comprehensive and simple models which deals with disease's various aspects, in the diabetes case, various model were discussed to date as simple models for example minimal model have advantages of utilizing a few measurable factors' small number. On the other hand, various comprehensive models attempts for representing the system (economic, clinical, biological, etc...) by considering every interaction as parameters. In this review paper, the primary goal was models' as well as studies' overview which deals with diagnosis's various aspects, diabetes progressions further care as well as management. Seven models were discussed by Bergman et al. (1979) before they selected the "best one" which after that turn out to be most popular minimal model that was highly useful applications and selected based on physiologically activity, having parameters assessed with a moderate accuracy, parameters which can express physiological and reasonable interpretations, for simulating the system dynamics with identifiable parameters' smallest number. But minimal model's various versions were discussed by many researchers for example the physical exercise was taken as parameter considered as a remarkable tool which enhances sensitivity of insulin ( $SI = (p3 + q3)(1 + p2)/P2$ ). Derouich and Boutayeb (2002). Regarding the practical usefulness of the model it was well acknowledged that in clinical patients the minimal model is used for the insulin sensitivity's routine evaluation. According to authors stated literature review of the present study focused on effective synthesis and utilization of aldohexose by IVGTT. In diabetes research, mathematical modeling's relative significance was studied in present review paper. One of the main

problem is how clinically relevant data can be acquired for validating the model as well as implement simulation. In conclusion, present review represented that mathematical model deduced the progression of long-term diabetes. Also in human regulatory systems, a significant issue is diabetes management. The present reviewed paper can demonstrates the glucose-insulin regulatory system's difference among a diabetic person and a normal person. In diabetic patient, levels of glucose concentration after a certain time not easily comes down that indicates the evidences that person is diabetic. The actual medical observations can be interpreted by mathematical model depending on the debated or shared assumptions, suggesting to the critical readers a control for further experimentation as well as hypotheses. In the present review study the models described about the minimal models of Bergman's model was better used to interpret an IVGTT, further this can't be efficiently explained by dynamic model.

### References:

1. G. A. Bocharov and F. A. Rihan, "Numerical modelling in biosciences using delay differential equations," *Journal of Computational and Applied Mathematics*, vol. 125, no. 1-2, pp. 183–199, 2000.
2. F. A. Rihan, D. H. Abdelrahman, F. Al-Maskari, F. Ibrahim, and M. A. Abdeen, "Delay differential model for tumour-immune response with chemoimmunotherapy and optimal control," *Computational and Mathematical Methods in Medicine*, vol. 2014, Article ID 982978, 15 pages, 2014.
3. C. T. H. Baker, G. A. Bocharov, C. A. H. Paul, and F. A. Rihan, "Modelling and analysis of time-lags in some basic patterns of cell proliferation," *Journal of Mathematical Biology*, vol. 37, no. 4, pp. 341–371, 1998.
4. S. Lakshmanan, F. A. Rihan, R. Rakkiyappan, and J. H. Park, "Stability analysis of the differential genetic regulatory networks model with time-varying delays and Markovian jumping parameters," *Nonlinear Analysis: Hybrid Systems*, vol. 14, pp. 1–15, 2014.
5. R. Rakkiyappan, G. Velmurugan, F. .Rihan, and S. Lakshmanan, "Stability analysis of memristor-based complex-valued recurrent neural networks with time delays," *Complexity*, vol. 21, no. 4, pp. 14–39, 2015.
6. F. A. Rihan, D. H. Abdel Rahman, S. Lakshmanan, and A. S. Alkhajeh, "A time delay model of tumour-immune system interactions: global dynamics, parameter estimation, sensitivity analysis," *Applied Mathematics and Computation*, vol. 232, pp. 606–623, 2014.
7. M. Gozen and C. Tunc, "Stability in functional integro-differential equations of second order with variable delay," *Journal of Mathematical and Fundamental Sciences*, vol. 49, no. 1, pp. 66–89, 2017.
8. Kaiser N, Leibowitz G, Neshet R. Glucotoxicity and  $\beta$ -cell failure in type 2 diabetes mellitus. *J Pediatr Endocrinol Metab* 2003; 16:5-22; PMID: 12585335.
- 9.

10. Reports of International Diabetes Federation Prevalence rate of Diabetes. (8th edition),2017.
11. Report of "Hindustan times", World Diabetes Day: Number of Indians with diabetes likely to double in next decade, (Nov 14,2017 ).
12. Aronoff SL, Berkowitz K, Shreiner B, Want L (2004). "Glucose metabolism and regulation: Beyond insulin and glucagon". Diabetes Spectrum. 17 (3): 183–90.[doi:10.2337/diaspect.17.3.183](https://doi.org/10.2337/diaspect.17.3.183). Archived from [the original](#) on 2019-12-17.
13. Ajmera, M Swat, C Laibe, N Le Novère and V Chelliah, CPT: Pharmacometrics & Systems Pharmacology (2013) The impact of mathematical modeling on the understanding of diabetes and related complications : I 2, e54; doi:10.1038/psp.2013.30.
14. WHO Diabetes fact sheet - (15 November 2017).
15. American Diabetes Association (2015). Classification and Diagnosis of Diabetes Diabetes Care; 38(Suppl. 1):S8–S16 | DOI: 10.2337/dc15-S005.
16. Bergman RN: The minimal model: yesterday, today and tomorrow. In The minimal model Approach and Determination of Glucose Tolerance Volume 7. Edited by: Bergman RN, Lovejoy JC. Boston : Louisiana state university Press; 1997:3-50.
17. Bergman RN: The minimal model of glucose regulation: a biography. In Mathematical Modeling in Nutrition and Health Edited by: Novotny, Green, Boston. Kluwer Academic/Plenum; 2001.
18. Nucci G, Cobelli C: Models of subcutaneous insulin kinetics: a critical review. Computer Methods and Programs in Biomedicine 2000, 62:249-257.
19. Sundell J, Knuuti J: Insulin and myocardial blood flow. Cardiovascular Research 2003, 57(2):312-319.
20. Mari A: Mathematical modelling in glucose metabolism and insulin secretion. Current Opinion Clinical Nutrition Metabolism Care 2002, 5:495-501.
21. Makroglou A, Li J, Kuang Y: Mathematical models and software tools for the glucose-insulin regulatory system and diabetes: an overview. Applied Numerical Mathematics 2006, 56:559-573.
22. Kalergis M, De Grandpre E, Andersons C: The Role of the Glycemic Index in the Prevention and Management of Diabetes: A Review and Discussion. Canadian Journal of Diabetes 2005, 29(1):27-38.
23. Atun R, Gurol-Urganci I: Health expenditure: an 'investment' rather than a cost? International Economics Programme; 2005.
24. . Boutayeb A: The double burden of communicable and non communicable diseases in developing countries: A review. Transactions of the Royal Society of Tropical Medicine and Hygiene 2006, 100:191-199.
25. R.D. Hernandez, D.J. Lyles, D.B. Rubin, Th.B. Voden, St.A. Wirkus, A model of  $\beta$ -cell mass, insulin, glucose and receptor dynamics with applications to diabetes, Cornell Univ., Dept. of Biometrics, Technical Report BU-1579-M, 2001

26. R.N. Bergman, C. Cobelli, Minimal modelling, partition analysis and the estimation of insulin sensitivity, *Federation Proc.* 39 (1980) 110–115.
27. R. Bertram, L. Satin, M. Zhang, P. Smolen, A. Sherman, Calcium and glycolysis mediate multiple bursting modes in pancreatic islets, *Biophys. J.* 87 (2004) 3074–3087.
28. Tipler, Paul A. (1991), *Physics for Scientists and Engineers: Extended version (3rd ed.)*, New York: [Worth Publishers](#), ISBN 0-87901-432-6
29. Andrea De Gaetano and Ovide Arino. Mathematical modelling of the intravenous glucose tolerance test. *Journal of Mathematical Biology*, 40:136–168, revised version February 2000.
30. Bukova-Guzel E., (2011). An examination of pre-service mathematics teachers' approaches to construct and solve mathematical modeling problems. *Teaching Mathematics and its applications*, 30(1): 19-36.
31. Brandeau M.L., (2005). Modeling complex Medical Decision Problems with Archimedes Model, *Annals of Internal Medicine*. 143: 303-304.
32. Dubey B., et al (2011). Modelling effects of Toxicant on uninfected cells, infected cells and immune response in the presence of virus, *Journal of Biological Systems* 19: 479-503.
33. Eddy D.M. and Schlessinger L., (2003). Archimedes: A trial-validated model of diabetes. *Diabetes Care* 26(11): 3093-3101.
34. Freedman H.I. and Shukla J.B., (1991). Models for the effect of toxicant in single species and predator-prey systems, *Journal of Mathematical Biology* 30: 15-30.
35. Kanpur J.N., (1988). *Mathematical modeling*, New Age International (P) Ltd., Publishers, New Delhi.
36. Bolie VW: Coefficients of normal blood glucose regulation. *J Appl Physiol* 1961, 16:783- 788.
37. Godslan IF, Agbaje OF, Hovorka R: Evaluation of nonlinear regression approaches to estimation of insulin sensitivity by the minimal model with reference to Bayesian hierarchical analysis. *Am J Physiol* 291:E167–E174, 2006
38. Zheng Y, Zhao M: Modified minimal model using a single-step fitting process for the intravenous glucose tolerance test in type 2 diabetes and healthy humans. *Comput Methods Programs Biomed* 79:73–79, 2005
39. G, Thomaseth K, Ahren B: Contribution to glucose tolerance of insulin-independent vs. insulin-dependent mechanisms in mice. *Am J Physiol* 281:E693–E703, 2001
40. Flanagan DE, Vaile JC, Petley GW, Phillips DI, Godslan IF, Owens P, Moore VM, Cockington RA, Robinson JS: Gender differences in the relationship between leptin, insulin resistance and the autonomic nervous system. *Regul Pept* 140:37–42, 2007
41. Chernick SS, Gardiner RJ, Scow RO: Restricted passage of insulin across capillary endothelium in perfused rat adipose tissue. *Am J Physiol* 253:E475–E480, 1987.
42. Bergman RN, Ider YZ, Bowden CR, Cobelli C: Quantitative estimation of insulin sensitivity. *Am*



J Physiol236:E667–E677, 1979

43. Ader M, Ni T-C, Bergman RN: Glucose effectiveness assessed under dynamic and steady state conditions: comparability of uptake versus production components. J Clin Invest 99:1187–1199, 1997.
44. Korytkowski MT, Berga SL, Horwitz MJ: Comparison of the minimal model and the hyperglycemic clamp for measuring insulin sensitivity and acute insulin response to glucose. Metabolism 44:1121–1125, 1995
45. Pacini G, Thomaseth K, Ahren B: Contribution to glucose tolerance of insulin- independent vs. insulin-dependent mechanisms in mice. Am J Physiol281:E693–E703, 2001
46. Makroglou A, Li J, Kuang Y: Mathematical models and software tools for the glucose- insulin regulatory system and diabetes: an overview. Applied Numerical Mathematics 2006, 56:559-573.
47. De Gaetano A, Arino O: Mathematical Modelling of the Intravenous Glucose Tolerance Test. J Math Biol 2000, 40:136-168.





## CERTIFICATE



**Lattice Science**  
Bibliographic Database

This certifies that the research paper entitled ‘**Evaluation of Various DR Techniques in Massive Patient Datasets using HDFS**’ authored by ‘**K. B. V. Brahma Rao, R Krishnam Raju Indukuri, P. Suresh Varma, M. V. Rama Sundari**’ was reviewed by experts in this research area and accepted by the board of ‘Blue Eyes Intelligence Engineering and Sciences Publication’ which has published in ‘**International Journal of Recent Technology and Engineering (IJRTE)**’, ISSN: 2277-3878 (Online), Volume-10 Issue-4, November 2021. Page No.: 1-6. on merit basis.

Your published paper available at: <https://www.ijrte.org/portfolio-item/d65081110421/>.

No article publication charges was given by the authors for publication of this article in the Journal.



Jitendra Kumar Sen  
(Manager)

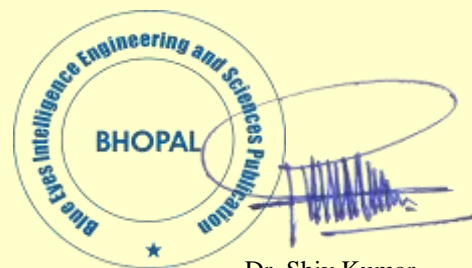

Dr. Shiv Kumar  
Editor-In-Chief

**RESEARCH ARTICLE**

## Domino Prins cyclisation for Stereoselective synthesis of Oxygen bridged bicyclic thioethers using Amberlyst-15

N. Prudhviraju<sup>1\*</sup>, R.L. Satyanarayana<sup>1</sup>, S. Ramesh<sup>1</sup>, J. Padmavathi<sup>1</sup>, B. Nagamani<sup>1</sup>,  
B. Jagan Mohan Reddy<sup>2</sup>, B. V. Subba Reddy<sup>3</sup>

<sup>1</sup>B.V. Raju College, Vishnupur, Bhimavaram, West Godavari District, 534202, India.

<sup>2</sup>Department of Organic Chemistry, Adikavi Nannaya University, Rajamahendravaram, 533105, India.

<sup>3</sup>Natural Product Chemistry, CSIR-Indian Institute of Chemical Technology, Tarnaka, 500007, Hyderabad, India

\*Corresponding Author E-mail: [prudhvi115@gmail.com](mailto:prudhvi115@gmail.com)

### ABSTRACT:

A domino reaction has been developed for the synthesis of Oxygen bridged bicyclic thio ethers through the coupling of 4-(2-mercaptoethyl)-1-methylcyclohex-3-en-1-ol with aldehydes in the presence of Amberlyst-15 in dichloromethane at 25°C. This method is a highly diastereoselective affording the corresponding bicyclic thio ethers i.e. (1R,4aR,7R,8aR)-7-methyl-1-(2,4,5-trifluorophenyl)octahydro-4a,7-epoxyisothiochromene in good yields with high selectivity. It is the first report on the synthesis of Oxygen bridged bicyclic thioethers using a domino Prins strategy.

**KEYWORDS:** Amberlyst-15, dichloromethane, 4-(2-mercaptoethyl)-1-methylcyclohex-3-en-1-ol, octahydro-4a, 7-epoxyisochromenes, Domino Prins.

### INTRODUCTION:

Oxygen bridged bicyclic core (englerin) is frequently found in various natural products such as englerin, orientalol, oxyphyllol and saniculamoid A etc (Figure 1).<sup>1</sup>

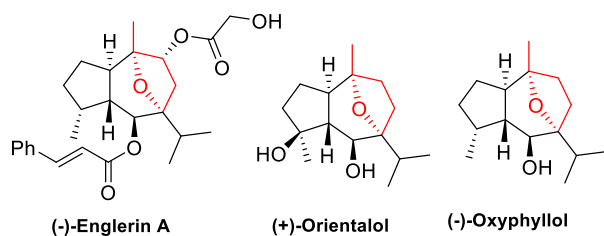

Figure1. Representative examples for Oxygen bridged bicycles

They are known to exhibit promising cytotoxicity against renal cancer cell lines.<sup>2</sup> Of various sulphur oxygenated heterocycles, tetrahydropyran ring is often present as a core structure of many biologically active natural products.<sup>3</sup>

Therefore, several efforts have been made to develop efficient synthetic approaches for the synthesis of these heterocycles.<sup>4</sup>

Among them, Prins cyclization is one of the most reliable strategies for the construction of tetrahydrothiopyran ring system.<sup>5,6</sup> In particular, Prins cascade is a highly convergent approach for the stereoselective synthesis of fused/bridged tetrahydrothiopyran derivatives.<sup>7,8</sup> Besides its potential use in natural products synthesis,<sup>9-10</sup> the scope of this cascade process has not yet been explored for the synthesis of Oxygen bridged thiobicycles from readily accessible aldehydes and 4-(2-mercaptoethyl)-1-methylcyclohex-3-en-1-ol. However, the development of a simple and metal-free approach for the construction of Oxygen bridged bicyclic thio ethers using inexpensive and readily available reagents is well appreciated. Recently, Amberlyst-15 has received a considerable attention in organic synthesis because of its low cost and ready availability.<sup>11</sup> The mild Lewis acidity associated with Amberlyst-15 has enhanced its use in organic synthesis to perform several organic transformations using stoichiometric levels to catalytic amounts.<sup>12</sup>

Received on 20.01.2021

Modified on 05.02.2021

Accepted on 19.02.2021

©AJRC All right reserved

Asian J. Research Chem. 2021; 14(2):125-131.

DOI: 10.5958/0974-4150.2021.00023.7

Following our interest on the catalytic application of Amberlyst-15,<sup>13</sup> we herein report a metal-free approach for the synthesis of Oxygen bridged thiobicycles from 4-(2-mercaptoethyl)-1-methylcyclohex-3-en-1-ol and aldehyde through a cascade of Prins cyclization. In a preliminary experiment, 4-(2-mercaptoethyl)-1-methylcyclohex-3-en-1-ol (**1**) was treated with p-fluorobenzaldehyde (**2**) in the presence of Amberlyst-15 in dichloromethane. To our delight, the reaction proceeded smoothly at room temperature to afford the corresponding oxygen bridged bicyclic thio ether **3a** in 82% yield (entry a, Table 1).



**Scheme 1.** Cascade cyclization of 4-(2-mercaptoethyl)-1-methylcyclohex-3-en-1-ol (**1**) with p-fluorobenzaldehyde (**2**).

## MATERIAL AND METHODS:

### General methods:

IR spectra were recorded on FT-IR spectrometer (KBr) and reported in reciprocal centimetres ( $\text{cm}^{-1}$ ).  $^1\text{H}$ NMR spectra were recorded at 500 MHz and  $^{13}\text{C}$  NMR at 125 MHz. For  $^1\text{H}$  NMR, tetramethylsilane (TMS) was used as internal standard ( $\delta = 0$ ) and the values are reported as follows: chemical shift, integration, multiplicity (s = singlet, d = doublet, t = triplet, q = quartet, m = multiplet), and the coupling constants in Hz. For  $^{13}\text{C}$  NMR,  $\text{CDCl}_3$  ( $\delta = 77.27$ ) was used as internal standard and spectra were obtained with complete proton decoupling. HRMS data were obtained using EI ionization.

### General Procedure for Products 3(a-n):

To a stirred solution of aldehyde (1.1 mmol) and **1a** or **1b** (1.0 mmol) in dichloromethane (5.0 mL), was added Amberlyst-15 at  $0^\circ\text{C}$ . The resulting mixture was stirred at  $25^\circ\text{C}$  for the specified time. The progress of the reaction was monitored by TLC using ethyl acetate and hexane as eluent. After completion, the mixture was quenched with water and the product was extracted with ethyl acetate. The organic layers were washed with aqueous sodium thiosulfate followed by brine solution and dried over anhydrous sodium sulfate. Removal of the solvent followed by purification on silica gel (Merck 100–200 mesh) using ethyl acetate/hexane (2:8) as eluent gave the pure tetrahydropyran.

### Characterization data for **1a**:

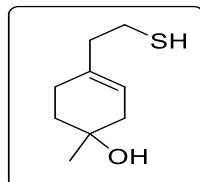

Light yellow Liquid;  $^1\text{H}$  NMR (500 MHz,  $\text{CDCl}_3$ ):  $\delta$  5.42 (s, 1H), 3.74–3.64 (m, 2H), 2.31–1.91 (m, 8H), 1.71 (td,  $J = 13.1, 7.1$  Hz, 1H), 1.64–1.54 (m, 1H), 1.24 (s, 3H) ppm;  $^{13}\text{C}$  NMR (125 MHz,  $\text{CDCl}_3$ ):  $\delta$  133.5, 121.3, 68.3, 60.0, 40.5, 39.5, 35.2, 28.8, 25.6 ppm; IR (neat):  $\nu$  3353.7, 2925.4, 1648.8, 1431.0, 1044.8, 764.5  $\text{cm}^{-1}$ ; HRMS ( $m/z$ ) calcd for  $\text{C}_9\text{H}_{16}\text{OS}$ : 172.09503, found: 172.0975.

### Characterization data for **1b**:

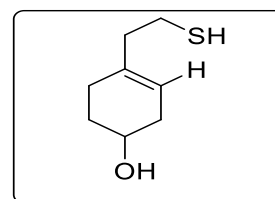

Light yellow Liquid;  $^1\text{H}$  NMR (500 MHz,  $\text{CDCl}_3$ ):  $\delta$  5.41 (s, 1H), 4.01–3.95 (m, 1H), 3.75–3.59 (m, 2H), 2.62–2.30 (m, 2H), 2.29–2.11 (m, 3H), 2.10–1.93 (m, 2H), 1.89–1.77 (m, 1H), 1.76–1.63 (m, 2H);  $^{13}\text{C}$  NMR (125 MHz,  $\text{CDCl}_3$ ):  $\delta$  133.9, 120.7, 66.2, 60.0, 40.6, 33.9, 30.4, 25.5 ppm; IR (neat):  $\nu$  3377.5, 2927.1, 1714.6, 1648.6, 1439.2, 1049.9, 758.7  $\text{cm}^{-1}$ ; HRMS ( $m/z$ ) calcd for  $\text{C}_8\text{H}_{14}\text{OS}$ : 158.08938, found: 158.08942.

## CHARACTERIZATION DATA OF PRODUCTS:

### **1-(4-fluorophenyl)-7-methyloctahydro-4a,7-epoxyisothiochromene (3a):**

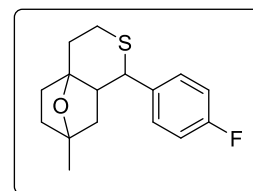

Light yellow Liquid;  $^1\text{H}$  NMR (500 MHz,  $\text{CDCl}_3$ ):  $\delta$  7.29–7.22 (m, 1H, Ar-H), 6.93–6.85 (m, 1H, Ar-H), 4.34 (dd,  $J = 1.0, 10.5$  Hz, 1H, H1), 4.01 (ddd,  $J = 1.2, 6.0, 11.5$  Hz, 1H, H5), 3.83 (ddd,  $J = 3.0, 11.5, 12.7$  Hz, 1H, H5'), 2.07 (ddd,  $J = 6.1, 12.8, 14.8$  Hz, 1H, H4), 2.01–2.03 (m, 1H, H4'), 2.04–1.95 (m, 1H, H2), 1.74–1.54 (m, 5H, H8, H8', H9, H9', H6), 1.49 (s, 3H, Me10), 1.15–1.10 (m, 1H, H6');  $^{13}\text{C}$  NMR (125 MHz,  $\text{CDCl}_3$ ):  $\delta$  156.1, 156.0, 154.2, 154.1, 150.4, 150.3, 150.2, 148.4, 148.3, 148.2, 148.1, 148.0, 146.2, 146.1, 124.5, 124.4, 116.7, 116.7, 116.6, 116.5, 105.5, 105.3, 105.2, 105.1, 84.5, 82.1, 75.7, 65.5, 48.8, 39.3, 37.4, 37.3, 30.0, 21.2 ppm;  $^{19}\text{F}$  NMR (470 MHz,  $\text{CDCl}_3$ ):  $\delta$  -118.98 (d,  $J = 15.5$  Hz), -134.32 (s), -134.36 (s), -142.24 (dd,  $J = 21.4, 15.6$  Hz); IR (neat):  $\nu$  2957.8, 2284.4, 1638.4, 1514.6, 1206.2, 767.9  $\text{cm}^{-1}$ ; HRMS ( $m/z$ ) calcd for  $\text{C}_{16}\text{H}_{17}\text{FOS}$ : 278.11806, found: 278.11750.

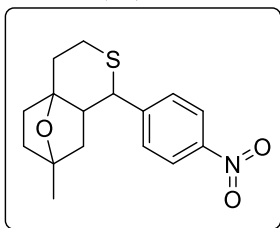
**7-methyl-1-(4-nitrophenyl)octahydro-4a,7-epoxyisothiochromene (3b):**

Light yellow Liquid;  $^1\text{H NMR}$  (500 MHz,  $\text{CDCl}_3$ ):  $\delta$  8.19 (d,  $J = 8.7$  Hz, 2H), 7.50 (d,  $J = 15.0$  Hz, 2H), 4.19–4.00 (m, 2H), 3.97–3.77 (m, 1H), 2.22–1.85 (m, 3H), 1.75–1.56 (m, 5H), 1.52 (s, 3H), 1.20–1.12 (m, 1H) ppm;  $^{13}\text{C NMR}$  (125 MHz,  $\text{CDCl}_3$ ):  $\delta$  148.2, 147.4, 128.0, 123.5, 84.6, 82.9, 82.1, 65.3, 49.1, 40.5, 37.5, 37.1, 30.1, 21.3 ppm; IR(neat):  $\nu$  2937.9, 2267.5, 1734.8, 1527.4, 1374.3, 1074.3, 819.6, 746.1  $\text{cm}^{-1}$ ; HRMS ( $m/z$ ) calcd for  $\text{C}_{16}\text{H}_{19}\text{NO}_3\text{S}$ : 305.11141, found: 305.11131.

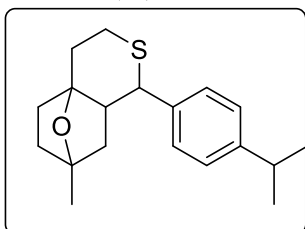
**1-(4-isopropylphenyl)-7-methyloctahydro-4a,7-epoxyisothiochromene (3c):**

Light yellow Liquid;  $^1\text{H NMR}$  (500 MHz,  $\text{CDCl}_3$ ):  $\delta$  7.26 (d,  $J = 8.1$  Hz, 2H), 7.18 (d,  $J = 8.1$  Hz, 2H), 4.09–3.99 (m, 1H), 3.99 (dd,  $J = 24.1, 5.7$  Hz, 1H), 3.84 (ddd,  $J = 12.9, 11.5, 2.8$  Hz, 1H), 2.98–2.78 (m, 1H), 2.14–2.05 (m, 2H), 1.98 (dd,  $J = 14.7, 1.9$  Hz, 1H), 1.73–1.54 (m, 4H), 1.49 (s, 3H), 1.22 (d,  $J = 7.0$  Hz, 6H), 1.17–1.11 (m, 1H);  $^{13}\text{C NMR}$  (125 MHz,  $\text{CDCl}_3$ ):  $\delta$  148.5, 137.7, 127.4, 126.4, 84.4, 83.7, 82.3, 65.3, 48.5, 40.7, 37.6, 37.3, 33.8, 30.3, 23.9, 23.9, 21.4 ppm; IR(neat):  $\nu$  2960.4, 2864.9, 1731.8, 1457.4, 1084.8, 822.5  $\text{cm}^{-1}$ ; HRMS ( $m/z$ ) calcd for  $\text{C}_{19}\text{H}_{26}\text{OS}$ : 302.17328, found: 302.17402.

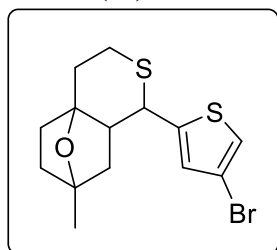
**1-(4-bromothiophen-2-yl)-7-methyloctahydro-4a,7-epoxyisothiochromene (3d):**

Light yellow Liquid;  $^1\text{H NMR}$  (500 MHz,  $\text{CDCl}_3$ ):  $\delta$  7.16 (d,  $J = 1.4$  Hz, 1H), 6.89 (d,  $J = 0.8$  Hz, 1H), 4.21 (d,  $J = 10.3$  Hz, 1H), 4.03 (ddd,  $J = 11.5, 6.0, 1.1$  Hz, 1H), 3.83 (ddd,  $J = 12.9, 11.5, 2.9$  Hz, 1H), 2.10–2.02 (m, 2H), 1.97 (dd,  $J = 14.8, 1.9$  Hz, 1H), 1.80 (dd,  $J = 12.5, 8.1$  Hz, 1H), 1.75–1.56 (m, 5H), 1.50 (s, 3H), 1.17 (dt,  $J = 12.5, 3.1$  Hz, 1H);  $^{13}\text{C NMR}$  (125 MHz,  $\text{CDCl}_3$ ):  $\delta$  145.4, 127.2, 122.3, 108.9, 84.6, 82.1, 78.7, 65.4, 49.2, 41.1, 37.3, 37.2, 30.0, 21.3 ppm; IR(neat):  $\nu$  2925.0, 1721.1, 1362.2, 1091.4, 765.6  $\text{cm}^{-1}$ ; HRMS ( $m/z$ ) calcd for  $\text{C}_{14}\text{H}_{17}\text{BrO}_2\text{S}_2$ : 343.99326, found: 343.99320.

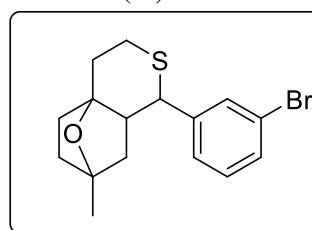
**1-(3-bromophenyl)-7-methyloctahydro-4a,7-epoxyisothiochromene (3e):**

Light yellow Liquid;  $^1\text{H NMR}$  (500 MHz,  $\text{CDCl}_3$ ):  $\delta$  7.51 (s, 1H), 7.41 (d,  $J = 7.8$  Hz, 1H), 7.26 (d,  $J = 6.3$  Hz, 1H), 7.19 (t,  $J = 7.8$  Hz, 1H), 4.04 (dd,  $J = 11.4, 5.9$  Hz, 1H), 3.96 (d,  $J = 10.3$  Hz, 1H), 3.88–3.78 (m, 1H), 2.15–1.93 (m, 3H), 1.75–1.54 (m, 5H), 1.50 (s, 3H), 1.18–1.08 (m, 1H);  $^{13}\text{C NMR}$  (125 MHz,  $\text{CDCl}_3$ ):  $\delta$  142.9, 130.9, 130.4, 129.8, 126.1, 122.5, 84.5, 83.2, 82.1, 65.3, 48.8, 40.5, 37.5, 37.2, 30.2, 21.3 ppm; IR(neat):  $\nu$  2936.7, 2861.8, 2357.3, 1717.0, 1609.4, 1371.5, 1262.7, 1020.2, 958.6, 770.9  $\text{cm}^{-1}$ ; HRMS ( $m/z$ ) calcd for  $\text{C}_{16}\text{H}_{19}\text{BrOS}$ : 338.03715, found: 338.03700.

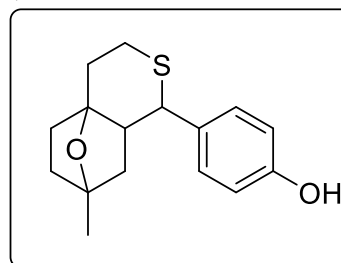
**4-(7-methyloctahydro-4a,7-epoxyisothiochromen-1-yl)phenol (3f):**

Light yellow Liquid;  $^1\text{H NMR}$  (500 MHz,  $\text{CDCl}_3$ ):  $\delta$  7.21 (d,  $J = 8.4$  Hz, 2H), 6.76 (d,  $J = 8.5$  Hz, 2H), 4.06–3.99 (m, 1H), 3.93 (d,  $J = 10.4$  Hz, 1H), 3.90–3.80 (m, 1H), 2.13–2.02 (m, 2H), 1.98 (dd,  $J = 14.8, 1.9$  Hz, 1H), 1.77–1.54 (m, 5H), 1.49 (s, 3H), 1.10–1.00 (m, 1H);  $^{13}\text{C NMR}$  (125 MHz,  $\text{CDCl}_3$ ):  $\delta$  155.3, 132.5, 129.0, 115.2, 84.5, 83.4, 82.4, 65.4, 48.6, 40.6, 37.5, 37.3, 30.3, 21.3 ppm; IR(neat):  $\nu$  3419.8, 2931.9, 2265.6, 1716.8, 1451.3, 1202.7, 1077.2, 764.1  $\text{cm}^{-1}$ ; HRMS ( $m/z$ ) calcd for  $\text{C}_{16}\text{H}_{20}\text{O}_2\text{S}$ : 276.12124, found: 276.12023.

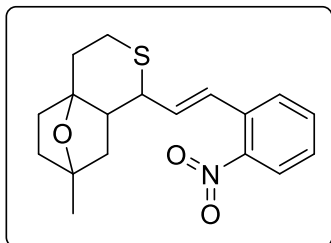
**(E)-7-methyl-1-(2-nitrostyryl)octahydro-4a,7-epoxyisothiochromene (3g):**

Light yellow Liquid;  $^1\text{H}$  NMR (500 MHz,  $\text{CDCl}_3$ ):  $\delta$  7.93 (d,  $J = 8.0$  Hz, 1H), 7.64–7.49 (m, 2H), 7.43–7.35 (m, 1H), 7.06 (d,  $J = 15.8$  Hz, 1H), 6.07 (dd,  $J = 15.9$ , 6.2 Hz, 1H), 4.04–3.96 (m, 1H), 3.88–3.64 (m, 2H), 2.08–1.91 (m, 2H), 1.90–1.78 (m, 2H), 1.73–1.54 (m, 4H), 1.52 (s, 3H), 1.28–1.20 (m, 1H);  $^{13}\text{C}$  NMR (125 MHz,  $\text{CDCl}_3$ ):  $\delta$  133.3, 133.0, 132.7, 128.7, 128.1, 126.6, 124.4, 84.5, 81.8, 81.3, 64.7, 47.3, 40.5, 37.5, 37.2, 30.2, 29.7, 21.3 ppm; IR(neat):  $\nu$  2947.8, 2862.9, 2275.5, 1738.8, 1528.4, 1372.5, 1004.7, 809.8, 745.6  $\text{cm}^{-1}$ ; HRMS ( $m/z$ ) calcd for  $\text{C}_{18}\text{H}_{21}\text{O}_3\text{N}$ : 331.12706, found: 331.12702.

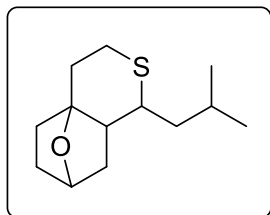
**1-isobutyloctahydro-4a,7-epoxyisothiochromene (3h):**

Light yellow Liquid;  $^1\text{H}$  NMR (500 MHz,  $\text{CDCl}_3$ ):  $\delta$  4.52 (t,  $J = 5.3$  Hz, 1H), 3.92 (ddd,  $J = 11.3$ , 5.8, 1.0 Hz, 1H), 3.60 (ddd,  $J = 12.7$ , 11.5, 2.9 Hz, 1H), 2.94 (td,  $J = 10.1$ , 1.9 Hz, 1H), 2.05–1.96 (m, 1H), 1.92 (dd,  $J = 14.6$ , 2.0 Hz, 1H), 1.87–1.73 (m, 1H), 1.63–1.57 (m, 2H), 1.53–1.44 (m, 3H), 1.33–1.20 (m, 3H), 1.10–1.03 (m, 1H), 0.89 (dd,  $J = 14.9$ , 6.0 Hz, 6H);  $^{13}\text{C}$  NMR (125 MHz,  $\text{CDCl}_3$ ):  $\delta$  81.9, 79.0, 64.6, 46.6, 42.5, 35.8, 35.0, 31.4, 30.1, 29.6, 24.3, 23.9, 21.6; IR(neat):  $\nu$  2955.2, 2864.9, 1733.7, 1464.2, 1108.1, 759.3  $\text{cm}^{-1}$ ; HRMS ( $m/z$ ) calcd for  $\text{C}_{13}\text{H}_{22}\text{OS}$ : 226.14198, found: 226.14189.

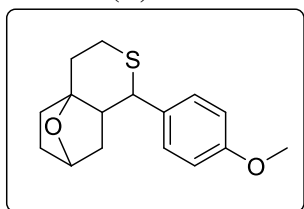
**1-(4-methoxyphenyl)octahydro-4a,7-epoxyisothiochromene (3i):**

Light yellow Liquid;  $^1\text{H}$  NMR (500 MHz,  $\text{CDCl}_3$ ):  $\delta$  7.31–7.23 (m, 2H), 6.89–6.83 (m, 2H), 4.56 (t,  $J = 5.1$  Hz, 1H), 4.07–4.01 (m, 1H), 3.90 (d,  $J = 10.3$  Hz, 1H), 3.86–3.80 (m, 1H), 3.79 (s, 3H), 2.21–2.08 (m, 1H), 2.04–1.96 (m, 2H), 1.86–1.75 (m, 1H), 1.61–1.53 (m, 2H), 1.51–1.33 (m, 3H) ppm;  $^{13}\text{C}$  NMR (125 MHz,  $\text{CDCl}_3$ ):  $\delta$  159.1, 132.4, 128.5, 113.6, 83.1, 82.0, 76.8, 65.2, 55.0, 46.9, 35.6, 34.4, 31.4, 29.8 ppm; IR(neat):  $\nu$  2929.3, 2860.3, 1730.4, 1614.7, 1513.6, 1247.5, 1083.8, 815.5  $\text{cm}^{-1}$ ; HRMS ( $m/z$ ) calcd for  $\text{C}_{16}\text{H}_{20}\text{O}_2\text{S}$ : 276.12124, found: 276.12223.

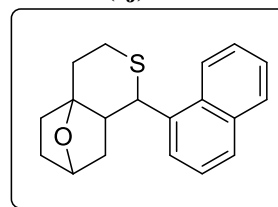
**1-(naphthalen-1-yl)octahydro-4a,7-epoxyisothiochromene (3j):**

White solid;  $^1\text{H}$  NMR (500 MHz,  $\text{CDCl}_3$ ):  $\delta$  8.31 (d,  $J = 8.5$  Hz, 1H), 7.84 (d,  $J = 7.8$  Hz, 1H), 7.79 (d,  $J = 8.1$  Hz, 1H), 7.56–7.36 (m, 4H), 4.62 (d,  $J = 10.6$  Hz, 1H), 4.57 (t,  $J = 5.2$  Hz, 1H), 4.17–4.08 (m, 1H), 4.00 (ddd,  $J = 13.1$ , 11.5, 2.7 Hz, 1H), 2.50–2.40 (m, 1H), 2.33–2.22 (m, 1H), 2.11 (dd,  $J = 14.8$ , 1.9 Hz, 1H), 1.89–1.78 (m, 1H), 1.70–1.57 (m, 2H), 1.52–1.39 (m, 2H), 1.37–1.29 (m, 1H);  $^{13}\text{C}$  NMR (125 MHz,  $\text{CDCl}_3$ ):  $\delta$  134.9, 134.2, 132.1, 128.7, 128.6, 125.9, 125.4, 125.2, 124.9, 124.6, 82.2, 81.2, 65.7, 45.2, 35.9, 35.0, 31.6, 30.1, 29.6; IR(neat):  $\nu$  2926.6, 2857.8, 2298.1, 1641.4, 1511.2, 1215.7, 1090.4, 771.0  $\text{cm}^{-1}$ ; HRMS ( $m/z$ ) calcd for  $\text{C}_{19}\text{H}_{26}\text{OS}$ : 296.12633, found: 296.12630.

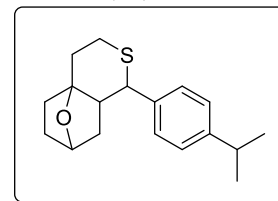
**1-(4-isopropylphenyl)octahydro-4a,7-epoxyisothiochromene (3k):**

Light yellow Liquid;  $^1\text{H}$  NMR (500 MHz,  $\text{CDCl}_3$ ):  $\delta$  7.28–7.24 (m, 2H), 7.18 (d,  $J = 8.1$  Hz, 2H), 4.56 (t,  $J = 5.0$  Hz, 1H), 4.07–3.99 (m, 1H), 3.92 (d,  $J = 10.4$  Hz, 1H), 3.82 (ddd,  $J = 13.1$ , 11.6, 2.7 Hz, 1H), 2.94–2.79 (m, 2H), 2.21–2.12 (m, 1H), 2.04–1.97 (m, 2H), 1.85–1.76 (m, 1H), 1.62–1.55 (m, 1H), 1.51–1.35 (m, 3H), 1.21 (d,  $J = 6.7$  Hz, 6H);  $^{13}\text{C}$  NMR (125 MHz,  $\text{CDCl}_3$ ):  $\delta$  129.0, 128.4, 127.2, 126.2, 83.4, 82.0, 76.8, 65.2, 46.7, 35.6, 34.5, 33.6, 31.4, 29.8, 23.7 ppm; IR(neat):  $\nu$  2960.4, 2863.9, 1727.6, 1638.3, 1084.7, 764.5  $\text{cm}^{-1}$ ; HRMS ( $m/z$ ) calcd for  $\text{C}_{18}\text{H}_{24}\text{OS}$ : 288.15763, found: 288.15642.

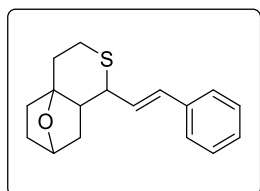

**(E)-1-styryloctahydro-4a,7-epoxyisothiochromene (3l):**

White solid;  $^1\text{H}$  NMR (500 MHz,  $\text{CDCl}_3$ ):  $\delta$  7.37 (d,  $J = 7.5$  Hz, 2H), 7.30 (t,  $J = 5.7$  Hz, 2H), 7.23 (t,  $J = 7.3$  Hz, 1H), 6.60 (d,  $J = 16.0$  Hz, 1H), 6.09 (dd,  $J = 16.0, 6.6$  Hz, 1H), 4.57 (t,  $J = 5.2$  Hz, 1H), 4.02 (dd,  $J = 11.4, 5.8$  Hz, 1H), 3.80–3.71 (m, 1H), 3.60 (dd,  $J = 10.1, 6.6$  Hz, 1H), 2.09 (ddd,  $J = 19.9, 13.8, 6.5$  Hz, 1H), 1.98 (dd,  $J = 14.7, 2.2$  Hz, 1H), 1.87–1.71 (m, 2H), 1.64–1.47 (m, 4H), 1.47–1.40 (m, 1H).  $^{13}\text{C}$  NMR (125 MHz,  $\text{CDCl}_3$ ):  $\delta$  136.7, 131.5, 128.4, 127.7, 127.6, 126.4, 81.7, 81.7, 77.1, 64.7, 45.9, 35.7, 34.6, 31.6, 29.9 ppm; IR(neat):  $\nu$  2929.2, 2860.9, 2271.1, 1728.7, 1645.9, 1454.7, 1100.1, 975.1, 747.7  $\text{cm}^{-1}$ ; HRMS ( $m/z$ ) calcd for  $\text{C}_{17}\text{H}_{20}\text{OS}$ : 272.12633, found: 272.12630.

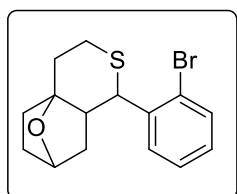
**1-(2-bromophenyl)octahydro-4a,7-epoxyisothiochromene (3m):**

Light yellow Liquid;  $^1\text{H}$  NMR (500 MHz,  $\text{CDCl}_3$ ):  $\delta$  7.55 (dd,  $J = 8.0, 1.1$  Hz, 1H), 7.44 (dd,  $J = 7.8, 1.6$  Hz, 1H), 7.34–7.29 (m, 1H), 7.14 (td,  $J = 7.9, 1.7$  Hz, 1H), 4.59 (t,  $J = 5.2$  Hz, 1H), 4.51 (d,  $J = 10.6$  Hz, 1H), 4.07–4.00 (m, 1H), 3.88 (ddd,  $J = 12.9, 11.5, 2.8$  Hz, 1H), 2.20–2.08 (m, 2H), 2.03 (dd,  $J = 14.7, 2.1$  Hz, 1H), 1.88–1.78 (m, 1H), 1.64–1.55 (m, 2H), 1.54–1.44 (m, 2H), 1.44–1.36 (m, 1H) ppm;  $^{13}\text{C}$  NMR (125 MHz,  $\text{CDCl}_3$ ):  $\delta$  139.4, 132.9, 129.3, 129.1, 127.6, 124.9, 82.1, 81.0, 77.1, 65.6, 46.8, 35.8, 33.5, 31.7, 29.9 ppm; IR(neat):  $\nu$  2925.5, 2860.5, 2361.9, 1708.1, 1611.9, 1465.4, 1204.5, 1076.9, 989.4, 753.4  $\text{cm}^{-1}$ ; HRMS ( $m/z$ ) calcd for  $\text{C}_{15}\text{H}_{17}\text{BrOS}$ : 324.02119, found: 324.02110.

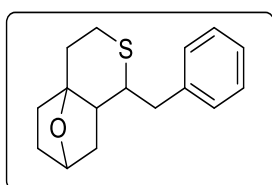
**1-benzyl octahydro-4a,7-epoxyisothiochromene (3n):**

Light yellow Liquid;  $^1\text{H}$  NMR (500 MHz,  $\text{CDCl}_3$ ):  $\delta$  7.31–7.25 (m, 2H), 7.24–7.17 (m, 3H), 4.52 (t,  $J = 5.2$  Hz, 1H), 3.93–3.85 (m, 1H), 3.56 (ddd,  $J = 12.9, 11.5, 2.8$  Hz, 1H), 3.24–3.17 (m, 1H), 2.73 (dd,  $J = 14.4, 3.2$  Hz, 1H), 2.61 (dd,  $J = 14.4, 8.5$  Hz, 1H), 2.06–1.96 (m, 1H), 1.90 (dd,  $J = 14.7, 1.8$  Hz, 1H), 1.83–1.73 (m, 1H), 1.67–1.56 (m, 2H), 1.55–1.43 (m, 3H), 1.34–1.27 (m, 1H);  $^{13}\text{C}$  NMR (125 MHz,  $\text{CDCl}_3$ ):  $\delta$  139.0, 129.2, 128.1, 126.0, 81.9, 81.9, 77.0, 64.7, 46.0, 39.7, 35.8, 35.3, 31.4, 30.0; IR(neat):  $\nu$  2926.1, 2864.8, 1738.5, 1474.6, 1106.3, 757.8  $\text{cm}^{-1}$ ; HRMS ( $m/z$ ) calcd for  $\text{C}_{16}\text{H}_{20}\text{OS}$ : 260.12633, found: 260.12629.

**RESULTS AND DISCUSSION:**

The relative stereochemistry of the compound **3a** has been derived by using 1D and 2D NMR experiments. The major NOE cross peaks are depicted in Figure 2. The large scalar coupling constant between H1 and H2 ( $^3J_{\text{H1-H2}}=10.5$  Hz) and the presence of NOE cross peak between H1/H5' indicate H1, H2 and H5' protons are in the axial positions in chair conformation as indicated in Figure 2. The stereochemistry at C2, C3 and C7 was derived by the observation of NOE cross peaks between H1/H6', H4'/H9, H6'/H8 imply the fused "O" is in the axial position whereas C6 in the equatorial position as indicated in Figure 2.

Inspired by the above results, we extended this method to various aldehydes like aromatic, heterocyclic and aliphatic aldehydes.

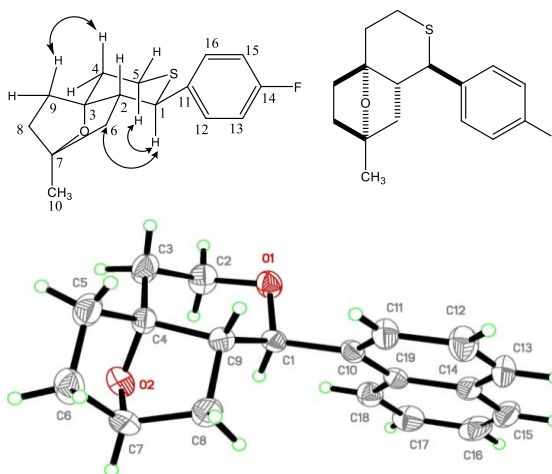

**Figure 2.** Characteristic nOe cross peaks of **3a** and ORTEP diagram of **3j**.

Interestingly, several aromatic aldehydes such as *p*-nitro-, *p*-isopropyl-, *m*-bromo-, *p*-hydroxy- derivatives participated well in this reaction (entries b, c, e and f, Table 1). Notably, electron-deficient substrate such as *p*-nitrobenzaldehyde also gave the desired product in good yield (entry b, Table 1). Furthermore, the reaction proceeded quite effectively with *p*-hydroxybenzaldehyde

with out the protection of hydroxyl group (entry f, Table 1). In case of aromatic aldehydes, the corresponding aryl substituted oxa-thio bicycles were obtained in good yields. In addition, heteroaromatic substrate, i.e. 4-bromothiophene-2-carboxaldehyde was also effective for this conversion (entry d, Table 1). In addition, the reaction was quite successful even with  $\alpha,\beta$ -unsaturated aldehydes such as 2-nitrocinnamaldehyde and cinnamaldehyde (entries g and l, Table 1). The scope of this cascade reaction was further exemplified by the coupling of 4-(2-mercaptoethyl)-1-methylcyclohex-3-en-1-ol with different aldehydes (entries h-n, Table 1). In all cases, the corresponding products were obtained in good yields. Finally, we attempted the coupling of 4-(2-mercaptoethyl)-1-methylcyclohex-3-en-1-ol with styrene oxide under the influence of a catalytic amount of

Amberlyst-15 in dichloromethane at 25°C. Interestingly, the desired product was obtained in 72% yield (entry n, Table 1). Therefore, this method was successful not only with aldehydes but also with epoxide.

The reaction was also carried out using commonly used catalysts such as Molecular Iodine, trifluoroacetic acid (TFA), *p*-toluenesulfonic acid (*p*-TSA),  $\text{BF}_3 \cdot \text{OEt}_2$  and TMSOTf. Among them, Amberlyst-15 was found to be the best catalyst in terms of conversion. Next, we examined the effect of solvents such as dichloromethane, acetonitrile, toluene and dimethoxyethane. Among them, dichloromethane gave the best results. No improvement in the conversion was observed either by increasing the reaction time or catalyst loading.

**Table 1. Synthesis of oxygen bridged thiobicycles**

Entry	Aldehyde (2)	Product (3)	Time (h)	Yield (%)
a			4	82
b			4	80
c			4	79
d			4	82

In the absence of Amberlyst-15, no cyclization was observed even after a long reaction time (24 h). The reactions proceeded smoothly at room temperature under mild and neutral conditions. No side products were detected under these conditions. No additives or stringent reaction conditions are required to facilitate the reaction. The scope and generality of this process is illustrated with respect to aldehydes and the results are presented in Table 1.

Entry	Aldehyde (2)	Product (3)	Time (h)	Yield (%)
e			3	80
f			3	69
g			4	80
h			2	78
i			4	70
j			3	80
k			4	78
l			5	76
m			3	73
n			4	72

All products were characterized by NMR, IR and mass spectroscopy. Yield refers to pure products after chromatography.

Mechanistically, the reaction was assumed to proceed *via* the formation of oxocarbenium ion from 4-(2-mercaptoethyl)-1-methylcyclohex-3-en-1-ol and aldehyde after activation with Amberlyst-15. A subsequent attack of the olefin on oxo-carbenium ion led to the formation of carbocation, which is simultaneously trapped with a tertiary hydroxyl group to furnish the desired bicyclic thio ether (Scheme 2). Alternatively, Amberlyst-15 is acidic Resin and which may be

responsible for the activation of aldehyde to facilitate the reaction.

### Scheme 2. A plausible reaction pathway

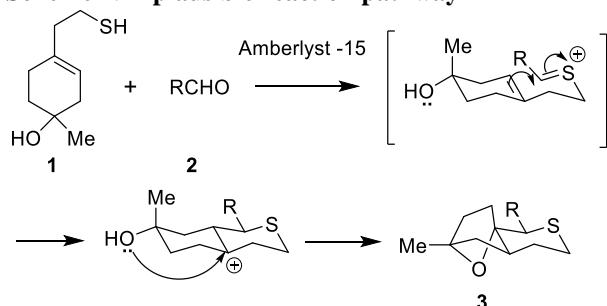

In this cascade process, the tertiary alcohol attacks preferentially from the less hindered side to produce the oxygen bridged thio bicycle **3** with high stereoselectivity. Recently, Barbero et al. also showed the preferential equatorial attack of internal nucleophile when termination of Prins cyclization occurs intramolecularly.<sup>14</sup>

### CONCLUSION:

We have demonstrated a novel metal-free approach for the synthesis of 1-(4-fluorophenyl)-7-methyloctahydro-4a,7-epoxyisothiochromene derivatives through a domino Prins cyclization between 4-(2-mercaptoethyl)-1-methylcyclohex-3-en-1-ol and aldehydes. The use of readily accessible precursors and inexpensive Amberlyst-15 makes it quite simple and more attractive. This method offers notable advantages such as mild/neutral conditions, good conversions and excellent selectivity.

### ACKNOWLEDGEMENTS:

Authors are thankful to the Department of Science and Technology (DST), Govt. of India for the financial assistance (F.No.SR/FT/CS-011/2019).

### REFERENCES:

- (a) B. M. Fraga, *Nat. Prod. Rep.*, 2012, 29, 1334. (b) D. A. Foley and A. R. Maguire, *Tetrahedron*, 2010, 66, 1131. (c) R. Ratnayake, D. Covell, T. T. Ransom, K. R. Gustafson and J. A. Beutler, *Org. Lett.*, 2009, 11, 57.
- F. J. Sulzmaier, Z. Li, M. L. Nakashige, D. M. Fash, W. J. Chain and J. W. Ramos, *PLoS One*, 2012, 7, e48032.
- (a) M. S. Kwon, S. K. Woo, S. W. Na and E. Lee, *Angew. Chem., Int. Ed.*, 2008, 47, 1733. (b) S. K. Woo, M. S. Kwon and E. Lee, *Angew. Chem. Int. Ed. Engl.*, 2008, 47, 3242. (c) E. A. Crane and K. A. Scheidt, *Angew. Chem. Int. Ed. Engl.*, 2010, 49, 8316. (d) P. A. Wender and A. J. Schrier, *J. Am. Chem. Soc.*, 2011, 133, 9228.
- (a) A. Guérinot, A. Serra-Muns, C. Gnam, C. Bensoussan, S. Reymond and J. Cossy, *Org. Lett.*, 2010, 12, 1808. (b) A. Aponick and B. Biannic, *Org. Lett.*, 2011, 13, 1330. (c) K. Tadpetch and S. D. Rychnovsky, *Org. Lett.*, 2008, 10, 4839. (d) D. Strand, P.-O. Norrby and T. Rein, *J. Org. Chem.*, 2006, 71, 1879. (e) H. Fuwa, N. Ichinokawa, K. Noto and M. Sasak, *J. Org.*

- Chem.*, 2012, 77, 2588.
- (a) D. R. Adams and S. P. Bhatnagar, *Synthesis*, 1977, 661. (b) B. B. Snider, in: *The Prins Reaction and Carbonyl Ene Reactions*, (ed. B. M. Trost, I. Fleming, C. H. Heathcock), Pergamon Press, New York, 1991, 2, 527.
- (a) I. M. Pastor and M. Yus, *Curr. Org. Chem.*, 2012, 16, 1277. (b) X. Han, G. R. Peh and P. E. Floreancig, *Eur. J. Org. Chem.*, 2013, 1193.
- (a) S. N. Chavre, P. R. Ullapu, S. J. Min, J. K. Lee, A. N. Pae, Y. Kim and Y. S. Cho, *Org. Lett.*, 2009, 11, 3834. (b) A. Barbero, A. Diez-Varga and F. J. Pulido, *Org. Lett.*, 2013, 15, 5234.
- (a) Z.-H. Chen, Y. -Q. Tu, S.-Y. Zhang and F. M. Zhang, *Org. Lett.*, 2011, 13, 724. (b) E. Fenster, C. Fehl and J. Aube, *Org. Lett.*, 2011, 13, 2614.
- (a) A. J. Bunt, C. D. Bailey, B. D. Cons, S. J. Edwards, J. D. Elsworth, T. Pheko and C. L. Willis, *Angew. Chem. Int. Ed.*, 2012, 51, 3901. (b) B. D. Cons, A. J. Bunt, C. D. Bailey and C. L. Willis, *Org. Lett.*, 2013, 15, 2046.
- H. M. Lee, C. N. Oberhuber and M. D. Shair, *J. Am. Chem. Soc.*, 2008, 130, 16864.
- Y. M. Ren, C. Cai and R. C. Yang, *RSC Adv.* 2013, 3, 7182.
- (a) V. Hojat, *Curr. Org. Chem.*, 2011, 15, 2438. (b) K. R. K. Reddy, I. M. L. Rosa, A. C. Doriguetto, E. L. Bastos, and L. F. Silva, Jr. *Molecules* 2013, 18, 11100.
- (a) N. P. Raju, B. J. M. Reddy, R. Anjibabu and B.V. S. Reddy, *Tetrahedron Lett.*, 2013, 54, 3639. (b) J. S. Yadav, G. Narasimhulu, N. Umadevi, Y. V. Reddy, Reddy and B. V. S. Reddy, *Tetrahedron Lett.*, 2013, 54, 871.
- A. Diez-Varga, H. Barbero, F. J. Pulido, A. Gonzalez-Ortega, and A. Barbero, *Chem. Eur. J.* 2014, 20, 14112.

# Design of Automated Solar Lawn Mover

<sup>1</sup>V. V. Vijetha Inti, <sup>2</sup>Ch. Rajya Lakshmi, <sup>3</sup>D. Mamatha, <sup>4</sup>G. Rama Swamy, <sup>5</sup>B. Kiran

<sup>1</sup>Assistant Professor, Department of EEE, Vishnu Institute of Technology, Bhimavaram, A.P., India

<sup>2</sup>Associate Professor, Department of Chemistry, Vishnu Institute of Technology, Bhimavaram, A.P., India

<sup>3</sup>Assistant Professor, Department of EEE, Vishnu Institute of Technology, Bhimavaram, A.P., India

<sup>4</sup>Assistant Professor, Department of Chemistry, Vishnu Institute of Technology, Bhimavaram, A.P., India  
Assistant Professor, Department of Physics, B.V.Raju College, Bhimavaram, A.P., India

**Abstract:-** Automation is rising quickly in the present technology. So mechanization assumes an imperative part in the horticultural field which is useful for the ranchers. In the previous days, the grass cutters utilized were physically handheld gadgets. Along these lines, there was contamination and loss of energy as they utilized gas and petroleum motors. So the old grass cutters should be supplanted via mechanized ones, where the framework will work for direction and hindrance discovery utilizing sunlight based energy as a force source.

**Keywords:** Automation, Solar energy, Grass cutter, Arduino

## 1. INTRODUCTION

In this paper we present an automated grass trimmer, fueled with sun based energy and ready to work just with the perfect energy from the sun; this one is an extraordinary contrast from the business ventures having a robot needing a charging station associated with the electrical matrix. It utilized Arduino UNO microcontroller board as the principle regulator of the framework, Ultrasonic sensor for object location, a NODE MCU for Wi-Fi association, a straight sharp edge for cutting the grass, and an engine drive for the wheels of the Robot. This is completely robotized and sustainable power based project. In Subsisting framework the gas or petroleum motors are used for the working of the grass cutting machines, yet in our plan we are made a grass shaper robot [1] which works by giving sunlight based energy as the source and the principle disadvantage of the remaining alive framework is it need a different individual to work the robot [2][3], to conquer this downside we are planning the robot with programmed block recognize and shirking by using the finish to stop switch, for the programming of the arduino microcontroller board we used the arduino programming and disentangled variant of c++ language as the programming language to indite the code.

In this paper we present a robotic lawn mower, fueled with sun powered energy and ready to work just with the perfect energy from the sun; this one is an incredible contrast from the business ventures having a robot [4] needing a charging station associated with the electrical matrix. When planning a grass cutter fueled by sun based energy, it is basic that the majority of the energy comes from the sun, and obviously a definitive outcome would be acquired if sun oriented energy were sufficient to totally control up the robot: this one is anyway a target that will be extremely hard to get, given the low effectiveness of existing sun based boards. In our venture the entire surface of the robot is bound to sunlight based boards, acting likewise as a cover: just the sides have been left free, and at any rate they wouldn't assume an unequivocal function in providing energy. Clearly, this decision represents a genuine imperative to the remainder of the undertaking, since in this way we previously characterized the greatest force accessible.

We need to consider that sunlight based power [5] won't generally be accessible, the same number of nursery territories are frequently in shade, or at any rate not straightforwardly hit by the sun, so we need to consider extensive misfortunes of influence. These misfortunes can be made up just if the robot has a gatherer fit for providing energy when it is missing from the sun. In this circumstance the battery functions as a cushion, collecting energy when it is bounty, and providing it when the robot, in actuality, is in shade. Starting here of view lead batteries are the most appropriate ones, however nothing restricts us to utilize batteries that can be performing more as far as weight and limit, similar to lithium ones. In full sun, the sun oriented board is equipped for reviving the inner battery with a flow at about 0.6A, adding up to about 8W, well under the force utilized by even the most proficient electric yard trimmer, fueled at 220Vac. This causes us to see as of now that an item like the one we're depicting in these pages can't substitute a physically worked yard trimmer totally, as this last one should be utilized from time to time, when the grass is excessively tall. Or maybe, the mechanical grass cutter can be utilized for a nonstop and consistent trimming of the grass.

These arrangements likewise offers a further bit of leeway, since the persistent taking care of guarantees that the lawn is consistently youthful and soft [6], and as it is cut in tiny pieces it is expected to decay itself in a brief timeframe, consequently filling in as preparation for the grass. You shouldn't expect the grass that has been sliced to be accumulated: in actuality, it will store itself among the grass cutting edges that have quite recently been cut.

For this sort of use, less force is required, and can be handily dealt with a battery fueled system [7]. The feeble force in play persuaded us to pick footing and a cutting motor with diminished force. Most likely, they may not totally suit the requirements of our perusers, who may in any case get the motors and the structure they like, contingent upon their spending plan and individual exigencies. To characterize the cutting zones in a yard, the underground wiring framework ends up being



simultaneously straightforward, precise and solid. It is additionally the best framework to characterize the work region of the robot.

Everything depends on the use of a straightforward electric wire, laid on the ground or somewhat under it, and associated with a control unit controlling the wire itself with a rotating electric sign at around 10 V and a recurrence of 34KHz. In the lower part of the body of the robot four little wheels are introduced, two on the front side, the other two on the rear, both alluding to an electric circuit shaped by a capacitor in equal. The circuit shaped by the equal inductance and the capacitor is called equal reverberating circuit and is determined with the goal that the strain at its closures, prompted by the outer attractive field, is at a most extreme when the attractive field shifts.

An reduced switch inverter [8] can be used if the motor used for the lawn mover is an AC motor. But the cost of the equipment and the process for the conversion of electrical energy will become high for the design of a specific inverter and the motor. A low cost inverter with less number of switches has been presented in [9]. Because of all these disadvantages a DC motors are used for the movement of grass cutter in lawn.

## 2. BLOCK DIAGRAM & WORKING:

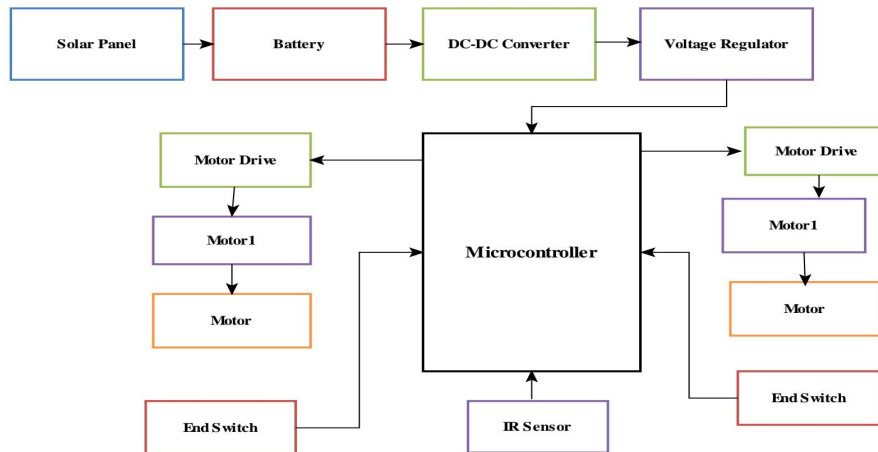

Figure 1. Block Diagram of Solar Lawn Mover

The square portrayal of our undertaking is appeared previously. It contains a few squares, for example, Micro Controller, Battery, Solar Panel, IR Sensor and 4-Channel Motor Driver IC, Solar board unit, voltage controller . At the point when we charge our battery through Buck-converter it goes about as a charge regulator which charges our battery to 13V in corresponding to that we will have connect rectifier to change tainted dc over to unadulterated dc structure. The voltage currently get controlled by utilizing two voltage controllers, utilizing 7805 we can keep up voltage level to 5 volts which is needed for the activity of nano and by utilizing 7812 we can keep up voltage level to 12 volts to work transfers and engine drivers. Normal producer semiconductor which is utilized here assumes a vital function for our whole activity, as a typical producer semiconductor producer is grounded and the base is associated with aurdino nano through 1k resistor, and authority is associated with the transfer where as opposite finish of hand-off is associated with Vcc pin of nano. At the point when voltage goes through the base of semiconductor producer and authority gets because of that momentum move through transfer and there by our controlling of our robot can be accomplished through driver circuit.

The plan contains a microcontroller, IR sensor, DC engine, end to stop switch all these together consolidated we get a grass shaper robot. End to stop switch and IR sensor to distinguish if the robot was going into an article. Security is the fundamental concern when planning a robot with cutting edges. Figuring out where to put our sensor and switch is pivotal to the general adequacy of our plan. The chip should be in the robot to shield it from the regular components. End to stop will be mounted straightforwardly before the robot for most extreme discovery. Batteries are use for power age for the robot development and the battery is battery-powered.

The driver circuits makes the engines to run by directions unloaded by a client in Arduino nano. At first when the switch of our grass trimmer is set to on then it begins to move in a straight manner until it is upset by any obstruction then the finish to stop switch is changed its state whether it to on or off it gives the sign to driver circuits to move in back dependent on the postpone given by the client in a nano and it take right bearing for a total turn then it begins to move straight until it upsets by any snag if that happens it again move back for a similar deferral however now it will move left way for complete pivot which is conceivable through aurdino regulator.

Turning on the strength button the engines pivoting forward way and the grass cutting engine withal enacts, the sharp edge which is adjusted to the grass cutting engine cut the grass, on the off chance that any check comes in the manner, at that point the infra red sensor recognizes the obstacle and imparts the sign to the microcontroller then according to the given program the miniature regulator change the revolution of one of the engine then two engines pivots in absolute opposite ways with one another then the hindrance is dodged. It used to charge the Battery which supplies Power to the Controller that coordinates all the parts in this Project Atmega328p-pu: It is the primary Micro Controller utilized n Arduino Uno Micro Controller Board. It is

a result of Atmel and most Advanced chip it is a 8-cycle miniature regulator dependent on the CMOS Technology, it has the 32k of blaze memory, 1k EEPROM, 2k of internal.

### 3. CONTROLLING EQUIPMENT

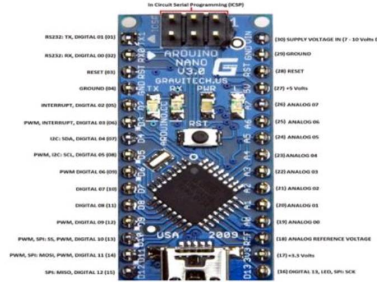

Figure 2. Arduino nano microcontroller board pin diagram

The Arduino board is planned so that it is simple for fledglings to begin with microcontrollers. This board particularly is breadboard neighborly is extremely simple to deal with the associations

**USB Jack:** Connect the small USB jack to a telephone charger or PC through a link and it will draw power needed for the board to work

**Vin Pin:** The Vin pin can be provided with an unregulated 6-12V to control the board. The on-board voltage controller directs it to +5V

**+5V Pin:** If you have a controlled +5V supply then you can straightforwardly give this o the +5V pin of the Arduino

**Information/yield:**

There are absolutely 14 advanced Pins and 8 Analog pins on your Nano board. The advanced pins can be utilized to interface sensors by utilizing them as information pins or drive loads by utilizing them as yield pins. A basic capacity like `pinMode()` and `digitalWrite()` can be utilized to control their activity. The working voltage is 0V and 5V for computerized pins. The simple pins can gauge simple voltage from 0V to 5V utilizing any of the 8 Analog pins utilizing a basic capacity compare `analogRead()`

These pins separated from filling their need can likewise be utilized for specific purposes which are examined underneath:

1. **Serial Pins 0 (Rx) and 1 (Tx):** Rx and Tx pins are utilized to get and communicate TTL sequential information. They are associated with the relating ATmega328P USB to TTL sequential chip.
2. **External Interrupt Pins 2 and 3:** These pins can be arranged to trigger a hinder on a low worth, a rising or falling edge, or an adjustment in worth.
3. **PWM Pins 3, 5, 6, 9 and 11:** These pins give a 8-cycle PWM yield by utilizing `analogWrite()` work.
4. **SPI Pins 10 (SS), 11 (MOSI), 12 (MISO) and 13 (SCK):** These pins are utilized for SPI correspondence.
5. **In-fabricated LED Pin 13:** This pin is associated with an implicit LED, when pin 13 is HIGH – LED is on and when pin 13 is LOW, its off.
6. **I2C A4 (SDA) and A5 (SCA):** Used for IIC correspondence utilizing Wire library.
7. **AREF:** Used to give reference voltage to simple contributions with `analogReference()` work
8. **Reset Pin:** Making this pin LOW, resets the microcontroller.

#### 3.1 END TO STOP SWITCHES



Figure 3. End to stop switch

A breaking point switch identifies the actual development of an item by direct contact with that object. An illustration of a cutoff switch is the switch that distinguishes the vacant situation of a vehicle entryway, naturally initiating the lodge light when the entryway is opened.

Recollect that the "ordinary" condition of a switch is the state of the base improvement. A breaking point switch will be in its "ordinary" state when it isn't in contact with anything (ie nothing that contacts the switch actuator instrument).

Cutoff switches find numerous utilizations in the business, especially in automated control and CNC machine device frameworks (Computer Numerical Control). In many movement control frameworks, versatile components have "homegrown" positions where the PC appoints a position estimation of zero. For instance, the controls of the hub of a CNC machine apparatus, for example, a machine or factory re-visitation of their "beginning" positions at the hour of dispatching, so the PC can know with certainty the underlying areas of each piece. These underlying positions are identified by limit switches. The PC



arranges that every servo engine voyages totally one way until a breaking point switch on every hub is set off. The position counter for every hub is reset to zero when as far as possible switch identifies that the underlying position has been reached.

An ordinary cutoff switch configuration utilizes a switch with a roller tip to connect with the moving part. The screw terminals on the switch body give association focuses the NC and NO contacts inside the switch. The majority of the breaking point switches in this plan share a "typical" terminal between the NC and NO contacts this way:

This switch contact plan is now and then alluded to as a structure C contact set, since it joins both a structure A contact (ordinarily open) just as a structure B contact (typically shut).

A nearby perspective on a few cutoff switches (utilized on a drum sequencer) shows the game plan of association terminals for structure C contacts. Each cutoff switch has its own "NO" (typically open), "NC" (ordinarily shut), and "C" (normal) screw terminal for wires to append.

Cutoff switches are utilized in an assortment of uses and conditions on account of their roughness, simplicity of establishment, and dependability of activity. They can decide the presence or nonattendance, passing, situating, and end of movement of an item. They were first used to characterize the restriction of movement of an item; thus "Limit Switch".

### 3.2 Battery(12V-7.2Ah)

#### 3.2.1 Working of Battery:

A battery is a gadget, which comprises of a different voltaic cells. Every voltaic cell comprises of two half cells associated in arrangement by a conductive electrolyte holding anions and feline particles. One half-cell incorporates electrolyte and the terminal to which anions move, for example the anode or negative terminal; the other half-cell incorporates electrolyte and the cathode to which feline particles move, for example the cathode or positive anode.

In the redox response that controls the battery, decrease happens to cations at the cathode, while oxidation happens to anions at the anode. The cathodes don't contact each other however are electrically associated by the electrolyte. Generally the half cells have various electrolytes. Everything considered each half-cell is encased in a holder and a separator that is permeable to particles however not the heft of the electrolytes forestall blending.

#### 3.3 Working of Lithium – Ion Battery

Lithium – Ion batteries are currently mainstream in lion's share of electronic compact gadgets like Mobile telephone, Laptop, Digital Camera, and so forth because of their enduring force effectiveness. These are the most mainstream battery-powered batteries with preferences like best energy thickness, irrelevant charge misfortune and no memory impact. Li-Ion battery utilizes Lithium particles as the charge transporters which move from the negative cathode to the positive terminal during release and back while charging. During charging, the outside current from the charger applies an over voltage than that in the battery. This powers the current to pass the opposite way from the positive to the negative terminal where the lithium particles get installed in the permeable anode material through a cycle called Intercalation. The Li-Ions go through the non fluid electrolyte and a separator stomach. The cathode material is intercalated lithium compound.

The negative cathode of the Li-Ion battery is comprised of carbon and the positive terminal is a metal oxide. The most ordinarily utilized material in the negative terminal is Graphite while that in the positive cathode might be Lithium cobalt oxide, Lithium particle phosphate or Lithium manganese oxide. Lithium salt in a natural dissolvable is utilized as the electrolyte. The electrolyte is regularly a combination of natural carbonates like Ethylene carbonate or Diethyl carbonate containing lithium particles. The electrolyte utilizes anion salts like Lithium hexafluoro phosphate, Lithium hexafluoro arsenate monohydrate, Lithium per chlorate, Lithium hexafluoro borate and so on Contingent on the salt utilized, the voltage, limit and life of the battery fluctuates. Unadulterated lithium responds with water energetically to frame lithium hydroxide and hydrogen particles. So the electrolyte utilized is non watery natural dissolvable. The electrochemical function of the terminals charge among anode and cathode relies upon the heading of current stream.

#### 3.3.2 Li Ion Battery Reaction

In the Li-Ion battery, both the terminals can acknowledge and deliver lithium particles. During the Intercalation cycle, the lithium particles move into the terminal. During the opposite cycle called de intercalation, the lithium particles move back. During releasing, the positive lithium particles will be removed from the negative terminals and embedded into the positive cathode. During the charging cycle, the converse development of lithium particles happens.

### 3.4 SOLAR PANEL



Figure 4. Solar Panel

Consistently, the sun emanates (conveys) a colossal measure of energy—called sunlight based energy. It transmits more energy in one day than the world uses in a single year. This energy comes from inside the sun itself. Like most stars, the sun is a major gas ball made up generally of hydrogen and helium gas. The sun makes energy in its internal center in a cycle called atomic combination. It takes the sun's energy simply barely eight minutes to venture to every part of the 93 million miles to Earth. Sun oriented energy goes at the speed of light, or 186,000 miles for every second, or  $3.0 \times 10^8$  meters for each second. Just a little

piece of the obvious brilliant energy (light) that the sun emanates into space actually arrives at the Earth, yet that is an excess. Consistently sun based energy arrives at the Earth to supply our country's energy needs for a year! Sun powered energy is viewed as a sustainable power source because of this reality. Today, individuals utilize sunlight based energy to warm structures and water and to produce power. Sunlight based energy represents an exceptionally little level of U.S. energy—short of what one percent. Sunlight based energy is generally utilized by habitations and to create power.

Sun oriented energy can likewise be utilized to deliver power. Two different ways to make power from sun based energy are photograph voltaics and sun oriented warm frameworks. Photovoltaic Electricity Photovoltaic comes from the words photograph, which means light, and volt, an estimation of power. In some cases photovoltaic cells are called PV cells or sun powered cells for short. You are most likely acquainted with photovoltaic cells. Sun oriented controlled toys, number crunchers, and side of the road call boxes all utilization sun powered cells to change over daylight into power. Sun powered cells are comprised of silicon, the very substance that makes up sand. Silicon is the second generally normal substance on Earth. Sunlight based cells can supply energy to anything that is fueled by batteries or electric force. Power is delivered when brilliant energy from the sun strikes the sun based cell, making the electrons move around. The activity of the electrons begins an electric flow. The transformation of daylight into power happens quietly and immediately. There are no mechanical parts to wear out. Contrasted with alternate methods of making power, photovoltaic frameworks are costly and numerous boards are expected to rise to the power created at different kinds of plants.

### 3.5 Dc Motor:



Figure 5. DC Motor

This Johnson Geared Motor from Robu.in gives force which falls moderate to the forces by focus shaft gear engines and side shaft dc gear engines, at a sensible expense.

It is a straightforward DC engine including metal gearbox for driving the shaft of the engine, so it is a precisely commutated electric engine which is fueled from DC supply. The Johnson Geared Motors are known for their reduced size and enormous force speed trademark.

The Johnson Motor accompanies side shaft otherwise called a helter-skelter shaft and six M3 mounting openings. The shaft of the engine prepares metal brambles which makes these DC gear engines Shaft wear safe. The shaft of the engine has an opening for better coupling.

The engine will run easily between the voltage range 6 to 18 V DC and give you 200 RPM at 12V inventory. It gives the force of 3.9 kg-cm at 200 RPM.

### 4. Working model of lawn mover



Figure 6(a) Solar Lawn mover

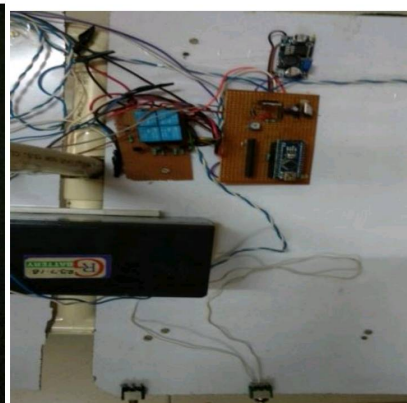

Figure 6 (b) Switching Circuit

The above figures 6(a) and 6(b) shows the working model of the sun based yard mover where the grass trimmer works freely with no outside help. Just on the off chance that we switch on the engine this yard mover will move all around the ground which cuts the additional grass in the grass and on the off chance that any outer aggravation happened, at that point the mover will turn back utilizing the finish to stop switch. Hence can move freely without any help of man.

### CONCLUSION

Fundamental Drawback of the Subsisting System is it need a different individual to work the Robot, so to conquer this downside a framework was actualized for completely robotized battery controlled grass shaper. As the innovation is getting progressed, highlights of grass cutters are additionally upgraded. The planned Model is profoundly effective and exact as it distinguishes the items and stops the development. Hence, the Design and execution of the task has been fruitful. Since there is no expense of fuel



and any sort of contamination as the current framework utilizes battery as a force source, the planned Robot will address the Difficulty of minimal effort of activity and an environmentally friendly power.

#### REFERENCES :

- [1] Vishal Danve, Anindu Bose and Varun Dhawan” Solar powered gardener” International Journal of Technical Research and Applications e-ISSN: 2320-8163, www.ijtra.com Special Issue 39 (KCCEMSR) (March 2016),PP. 39-43
- [2] Mohammad Baloch, Taj; Timothy Thien Ching Kae; , "Design and modelling a prototype of a robotic lawn mower," Information Technology, 2008. ITSIm 2008. International Symposium on , vol.4, no., pp.1-5, 26-28 Aug. 2008.
- [3] Yu Zhiqiang; Gao Meng; Deng Xiaoyan; Du Liqiang; He Chaofeng; Di Jianhong; Yang Yong; Shi Yanhui; Hu Liqiang; , "APF obstacle avoidance in polar coordinates for mobile robot based on laser radar,"Advanced Computer Control (ICACC), 2010 2nd International Conference on , vol.1, no., pp.549-552, 27-29 March 2010.
- [4] Tsubata, K.; Suzuki, K.; Mikami, S.; Osawa, E.-I.; , "Recognition of lawn information for mowing robots," Autonomous Robots and Agents, 2009. ICARA 2009. 4th International Conference on , vol., no., pp.15- 20, 10-12 Feb. 2009.
- [5] Pratik Adhav,ShivajiKolekar “Manufacturing Of Solar Operated Grass Cutter Machine”,International Engineering Research Journal (IERJ), Volume 2 Issue 8 Page 2785-2788, 2017 ISSN 2395-1621
- [6] Muhammad Wasif “Design and Implementation of Autonomous Lawn-Mower Robot Controller” 7th International Conference on Emerging Technologies ... 978-1-4577-0768-1/11/\$26.00 ©2011 IEEE
- [7] BibekanandaPatra,SambhunathNandy “Lawn Mower Trajectory Tracking By Wheeled Mobile Robot: Its Consequences”, 2017, 978-1-5386-1703-8/17, 2017 IEEE
- [8] Design and Implementation of Dual Switch Inverter Fed from Renewable Energy Sources, Mrs.V.V.Vijetha Inti, Dr.V.S.Vakula, TEST Engineering and Management,Volume 83,Page Number: 13993 – 13999,Publication Issue:March - April 2020
- [9] Design And Matlab/Simulink Implementation Of Four Switch Inverter For Microgrid Utilities,Mrs.V.V.Vijetha Inti, Dr.V.S.Vakula, Energy Procedia, vol 117,pages: 615-625,2017